



TAI-SAW TECHNOLOGY CO., LTD.

No. 3, Industrial 2nd Rd., Ping-Chen Industrial District,
Taoyuan, 324, Taiwan, R.O.C.

TEL: 886-3-4690038 FAX: 886-3-4697532

E-mail: tstsales@mail.taisaw.com Web: www.taisaw.com

Product Specifications Approval Sheet

Product Description: 250 MHz 0.15MHz BW SMD 5.0 x 5.0 mm SAW RF Filter

TST Parts No.:TA2050A

Customer Parts No.: _____

Company: _____
Division: _____
Approved by : _____
Date: _____

Checked by: _____ Kazuma Lee *Kazuma Lee*

Approval by: _____ Bob Chau *Bob Chau*

Date: _____ 10 / 12 / 2015

1. Customer signed back is required before TST can proceed with sample build and receive orders.
2. Orders received without customer signed back will be regarded as agreement on the specifications.
3. Any specifications changes must be approved upon by both parties and a new revision of specifications shall be released to reflect the changes.



TAI-SAW TECHNOLOGY CO., LTD.

No. 3, Industrial 2nd Rd., Ping-Chen Industrial District,
Taoyuan, 324, Taiwan, R.O.C.

TEL: 886-3-4690038 FAX: 886-3-4697532

E-mail: tstsales@mail.taisaw.com Web: www.taisaw.com

SAW Filter 250 MHz

MODEL NO.:TA2050A

REV. NO.1

A. MAXIMUM RATING:

1. Input Power Level: 10 dBm
2. DC Voltage : 0V
3. Operating Temperature: -20 °C to +70 °C
4. Storage Temperature: -40 °C to +85 °C



Electrostatic Sensitive Device

B. ELECTRICAL CHARACTERISTICS:

Item	Unit	Min.	Typ.	Max.
Center frequency Fc	MHz	-	250	-
1dB BW	KHz	150	317	-
3dB BW	KHz	-	440	-
Minimum insertion loss IL(min) Incl. loss of matching elements *1)	dB	-	2.5	3.5
Passband (relative to IL _{min}) *1) 249.925 ~ 250.075 MHz	dB	-	0.2	1.5
Attenuation (relative to IL _{min}) *1)				
10.00 ~ 207.00 MHz	dB	50	57	-
207.0 ~ 244.0 MHz	dB	33	39	-
244.0 ~ 249.0 MHz	dB	15	22	-
251.0 ~ 269.0 MHz	dB	10	17	-
269.0 ~ 400.0 MHz	dB	39	48	-
400.0 ~ 1000.0 MHz	dB	50	60	-
Source Impedance	ohm		50	
Load Impedance	ohm		50	

*1) : The matching circuit is real by actual passive components.
 0805 Coillcraft CS series chip conductor is used for inductor.
 0402 muRata GRM series is used for capacitor.

C. FREQUENCY CHARACTERISTICS:

(1) Narrow band Response:

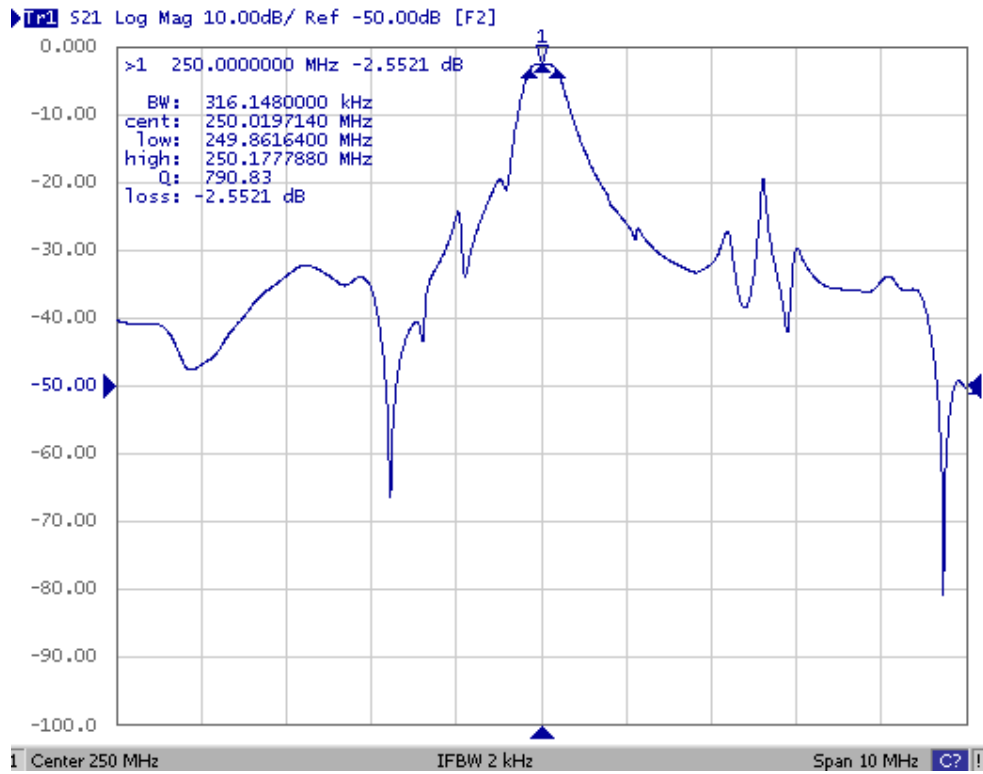

(2) Wide band Response:

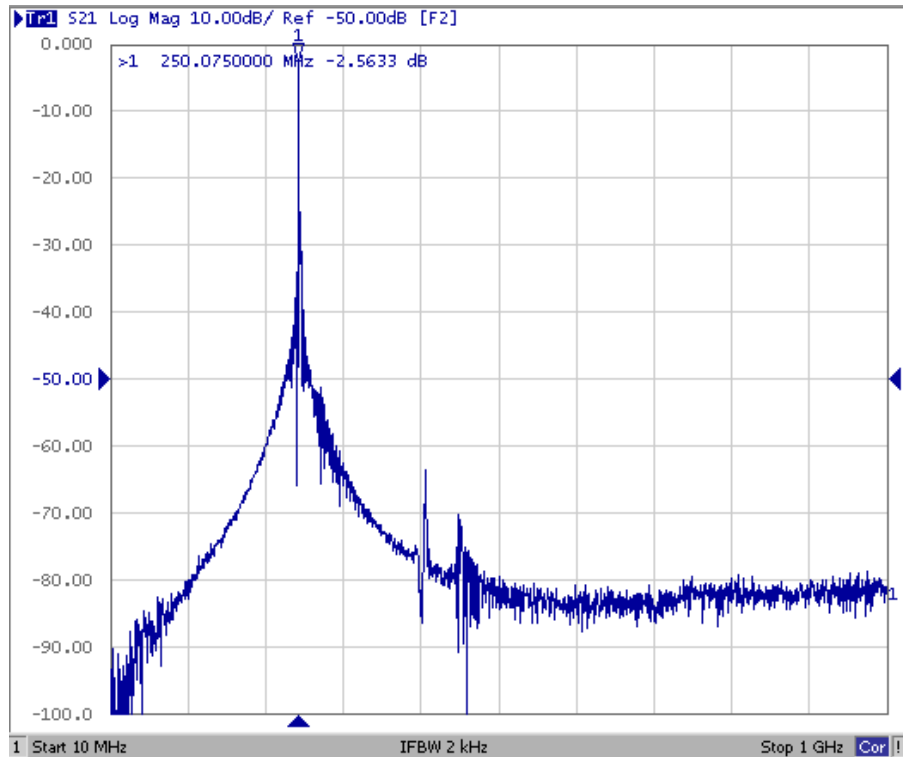

(3) Impedance:

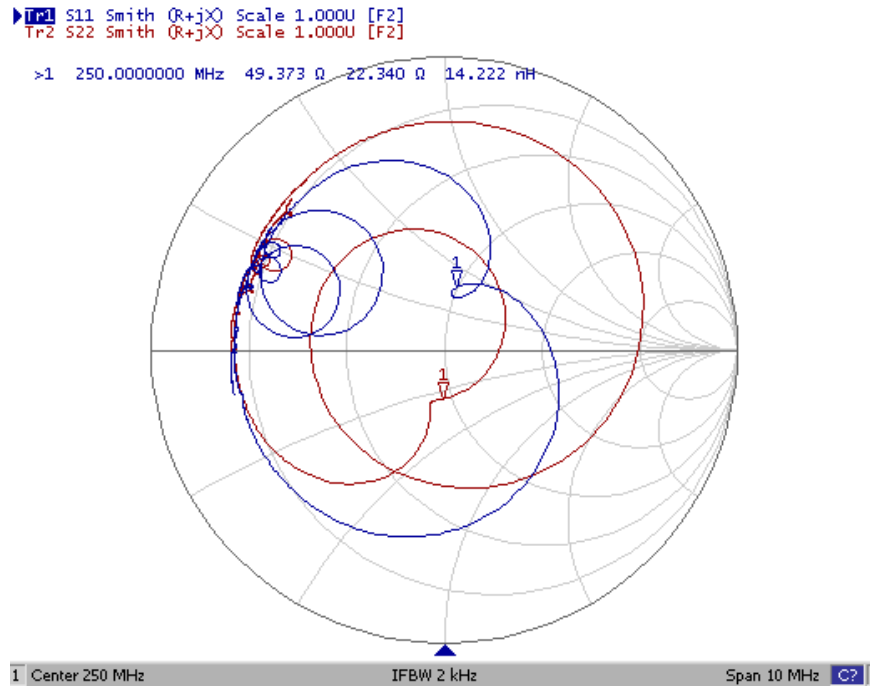

D. MEASUREMENT CIRCUIT:

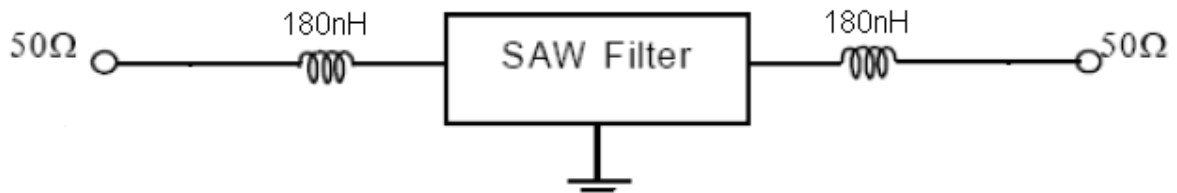

E.OUTLINE DRAWING:

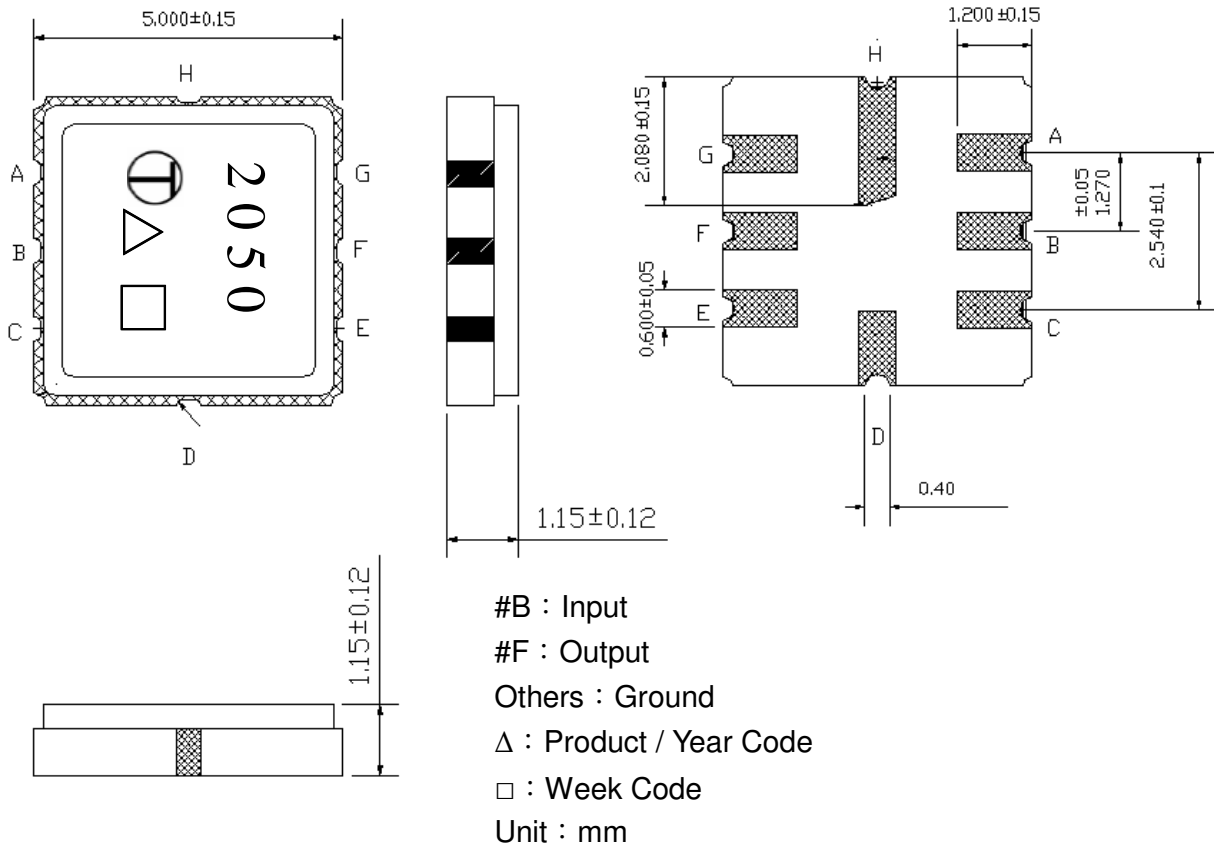

Year	2013	2014	2015	2016
	2017	2018	2019	2020
	2021	2022	2023	2024
Year Code	A	a	<u>A</u>	<u>a</u>

Week Code Table

WK01	WK02	WK03	WK04	WK05	WK06	WK07	WK08	WK09	WK10	WK11	WK12	WK13
A	B	C	D	E	F	G	H	I	J	K	L	M
WK14	WK15	WK16	WK17	WK18	WK19	WK20	WK21	WK22	WK23	WK24	WK25	WK26
N	O	P	Q	R	S	T	U	V	W	X	Y	Z
WK27	WK28	WK29	WK30	WK31	WK32	WK33	WK34	WK35	WK36	WK37	WK38	WK39
a	b	c	d	e	f	g	h	i	j	k	l	m
WK40	WK41	WK42	WK43	WK44	WK45	WK46	WK47	WK48	WK49	WK50	WK51	WK52
n	o	p	q	r	s	t	u	v	w	x	y	z

F. PCB FOOTPRINT:

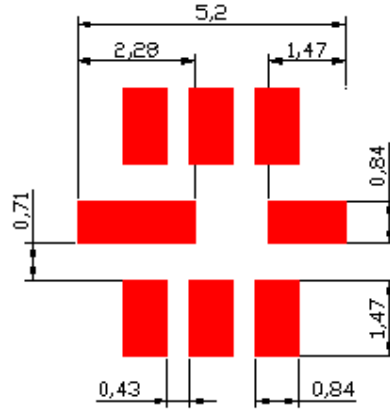

G. PACKING:

1. REEL DIMENSION

(Please refer to FR-75D10 for packing quantity)

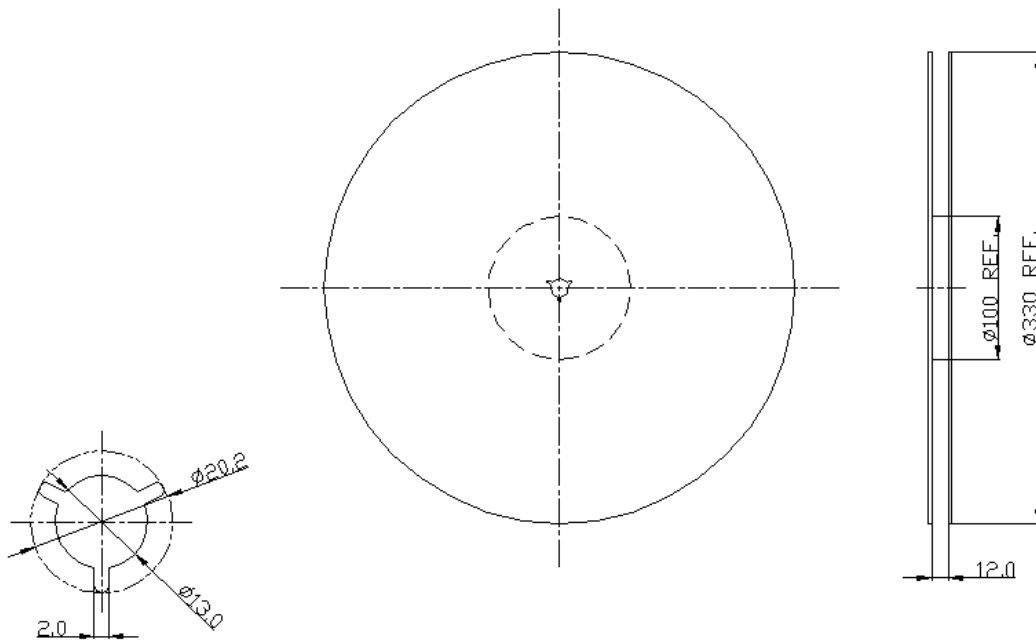

2. TAPE DIMENSION

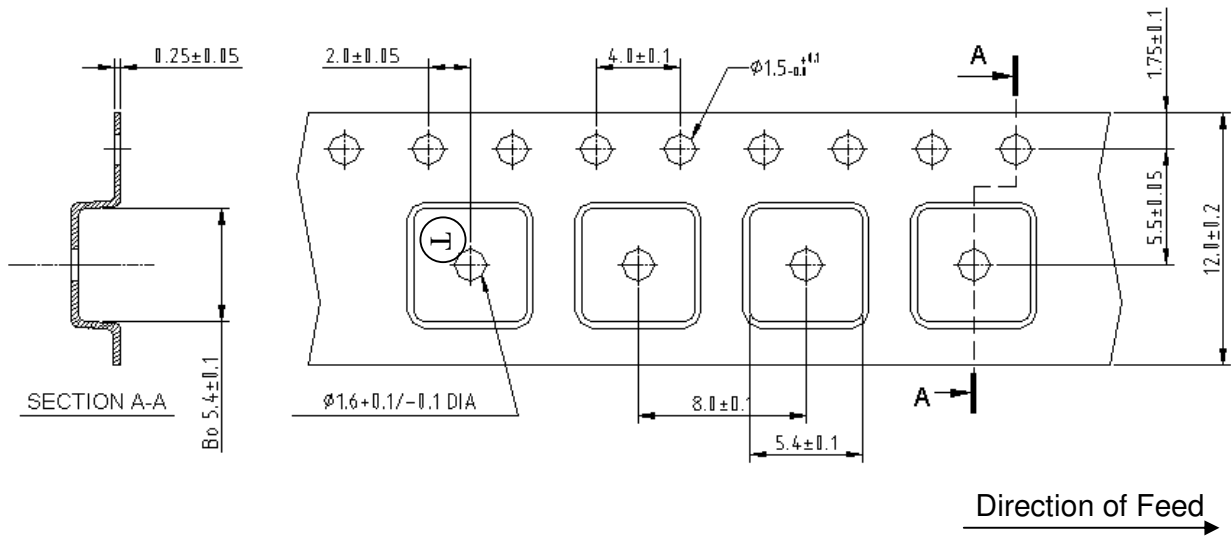

H. Recommended Reflow Profile:

1. Preheating shall be fixed at $150 \sim 180^{\circ}\text{C}$ for 60~90 seconds.
2. Ascending time to preheating temperature 150°C shall be 30 seconds min.
3. Heating shall be fixed at 220°C for 50~80 seconds and at $260^{\circ}\text{C} \pm 0/-5^{\circ}\text{C}$ peak (20~40sec).
4. Time: 2 times.

