



# SAW TECHNOLOGY CO., LTD.

No. 3, Industrial 2nd Rd., Ping-Chen Industrial District,  
Taoyuan, 324, Taiwan, R.O.C.

TEL: 886-3-4690038 FAX: 886-3-4697532

E-mail: [tstsales@mail.taisaw.com](mailto:tstsales@mail.taisaw.com) Web: [www.taisaw.com](http://www.taisaw.com)

## Approval Sheet For Product Specification

Issued Date:

Product Name: SAW Filter 70MHz SMD 13.3x6.5mm

TST Parts No.: TB0185A

Customer Parts No.: \_\_\_\_\_

Company: _____
Division: _____
Approved by : _____
Date: _____

Checked by: Ricky Lee *Ricky*

Approval by: Francis Chen *Francis*

Date: 2009/02/24



# TAI-SAW TECHNOLOGY CO., LTD.

No. 3, Industrial 2nd Rd., Ping-Chen Industrial District,  
Taoyuan, 324, Taiwan, R.O.C.

TEL: 886-3-4690038 FAX: 886-3-4697532

E-mail: [tstsales@mail.taisaw.com](mailto:tstsales@mail.taisaw.com) Web: [www.taisaw.com](http://www.taisaw.com)

## IF SAW Filter 70MHz(BW=7MHz) SMD 13.3X6.5mm

MODEL NO.: TB0185A

REV.2.0

### A. MAXIMUM RATING:

1. Operating Temperature: 0 °C ~ +70 °C
2. Storage Temperature: -40 °C ~ +85 °C
3. Input power: 10dBm

RoHS Compliant  
Lead free  
Lead-free soldering

### B. Characteristics :

Ambient Temperature: 25 °C

Parameter	Unit	Min.	Typ.	Max.
Center frequency, Fc	MHz	69.8	70	70.2
Insertion Loss, IL	dB	-	21	23
1 dB Bandwidth	MHz	7.0	7.3	-
3 dB Bandwidth	MHz	7.3	7.9	-
40 dB Bandwidth	MHz	-	10.2	10.75
Amplitude ripple (within ±2.8MHz)	dB	-	0.8	1
Phase Linearity (within ±2.92MHz) (rms)	deg	-	2.5	6
Group Delay ripple (within ±2.92MHz)	nsec	-	50	100
Absolute Delay	μsec	-	1.02	-
Attenuation (Reference level from 0 dB)				
10 ~ 64MHz	dB	55	60	-
76~140MHz	dB	55	60	-
Substrate Material	-	-	LT	-
Temperature Coefficient	ppm/ °C	-	-18	-
Ambient Temperature	°C	-	25	-

### C. Frequency Characteristics :

#### 1. S21 Response: (span : 50MHz)

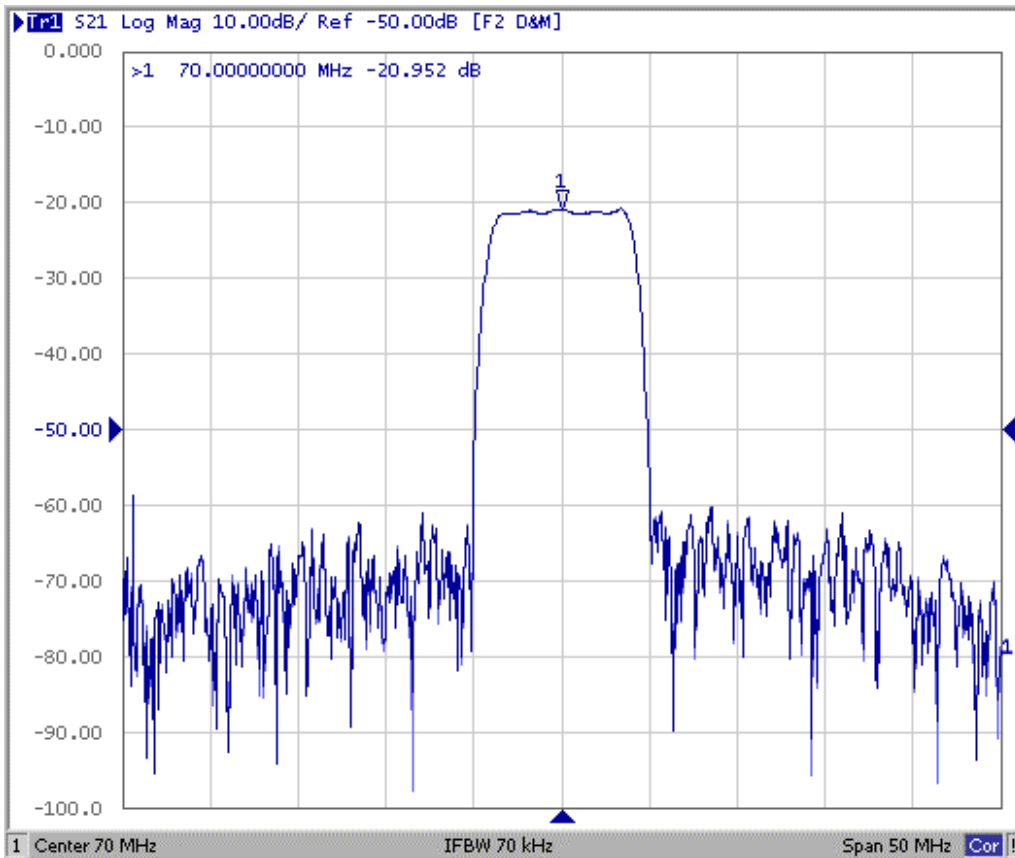

Fig1. Horizontal: 5MHz/Div Vertical: 10dB/Div

#### 2. Group-Delay Ripple: (span : 15MHz)

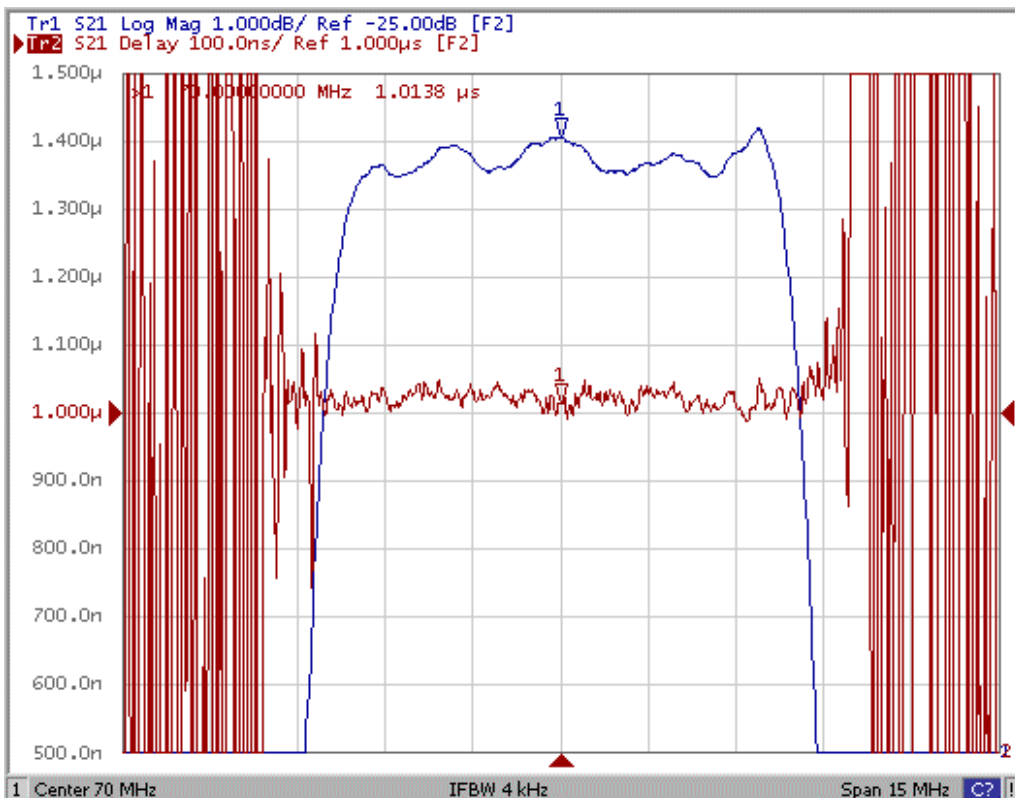
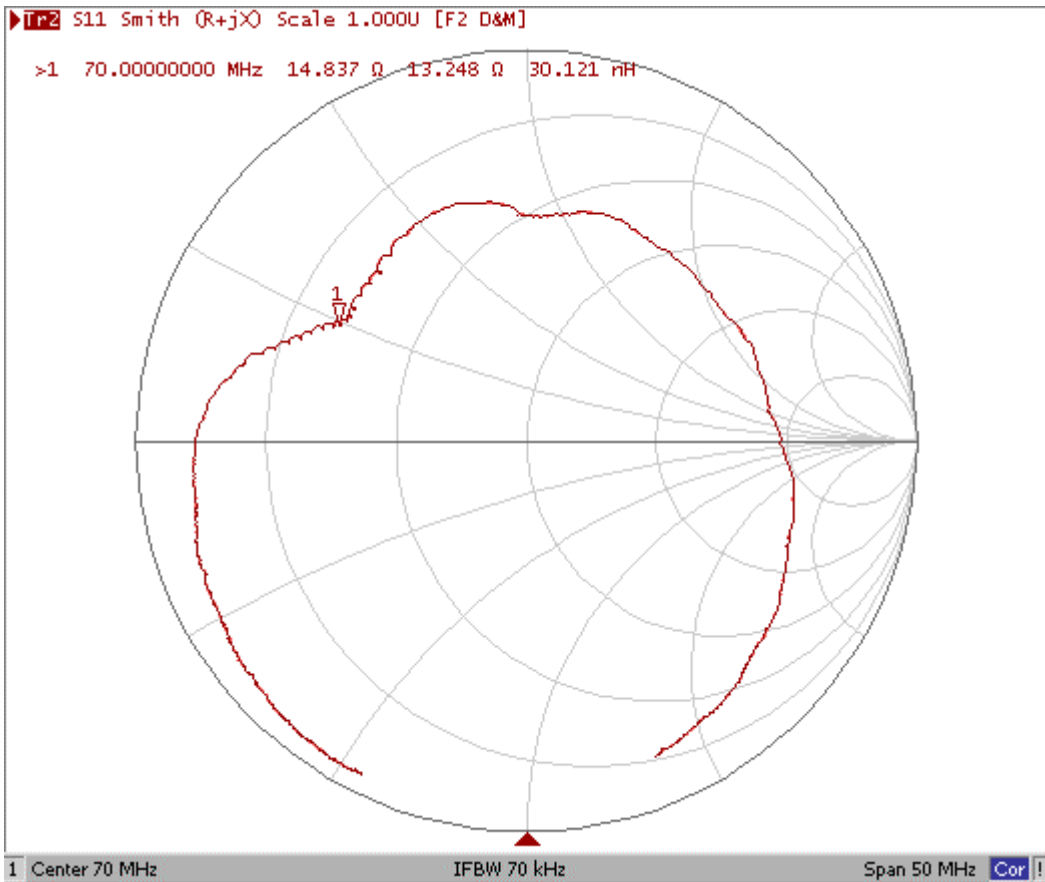
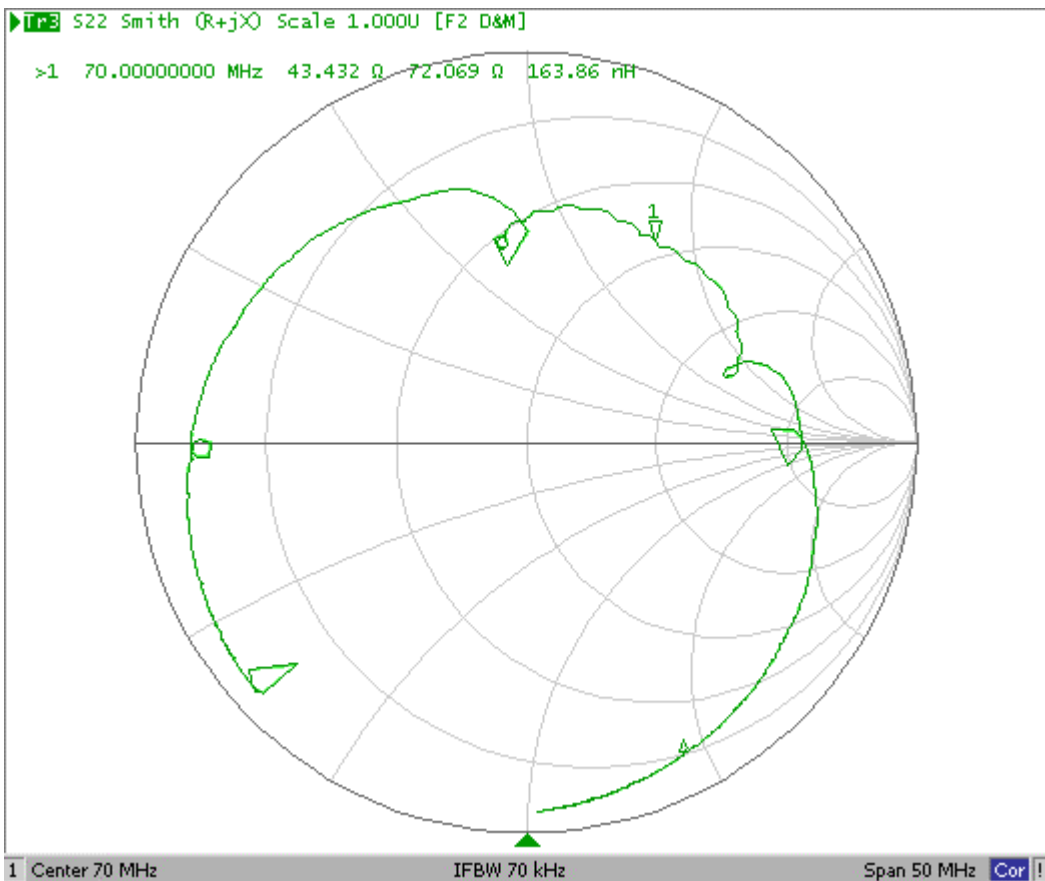

Fig2. Horizontal: 1.5MHz/Div Vertical: 100nec/Div

### 3. S11 Smith Chart: (span : 50MHz)



### 4. S22 Smith Chart (span : 50MHz)



**D. Measurement Circuit:**

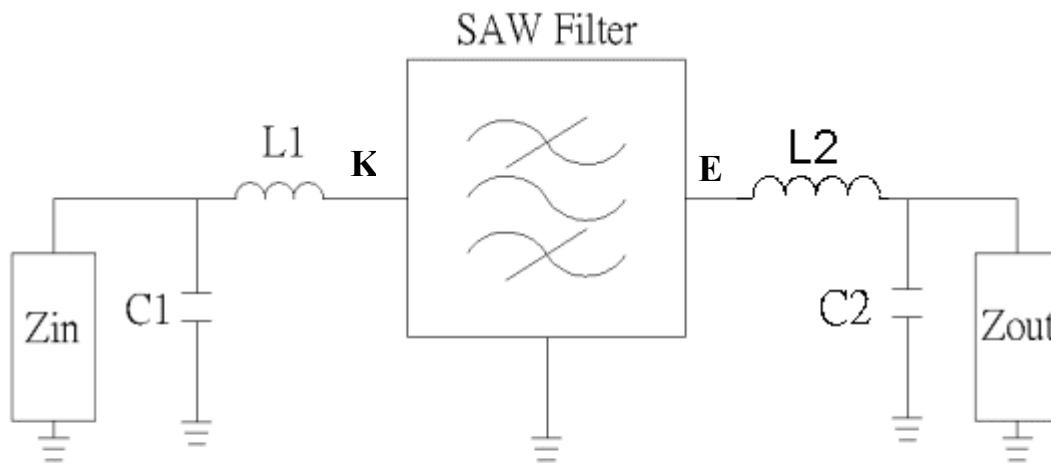

Zin and Zout are 50 Ω.

L1=180 nH, C1=47 pF, L2=180 nH, C2= 52 pF

**E. Outline Drawing:**

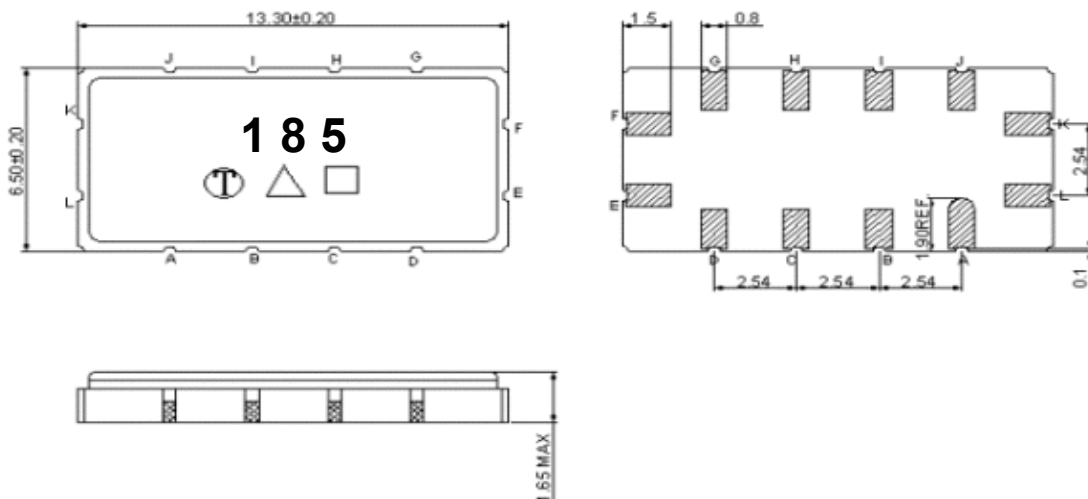

Pin K: RF input

Pin E: RF output

Pin A, B, C, D, G, H, I, L, F, J: To be Ground

□ : Week Code (Follow the table from planner each year)

Unit : mm (week01, 02, 03...52 =>A, B, C...z)

△ : Product / Year Code

Year	2005 2009	2006 2010	2007 2011	2008 2012
Product Code	B	b	<u>B</u>	<u>b</u>

**F. PCB Footprint:**

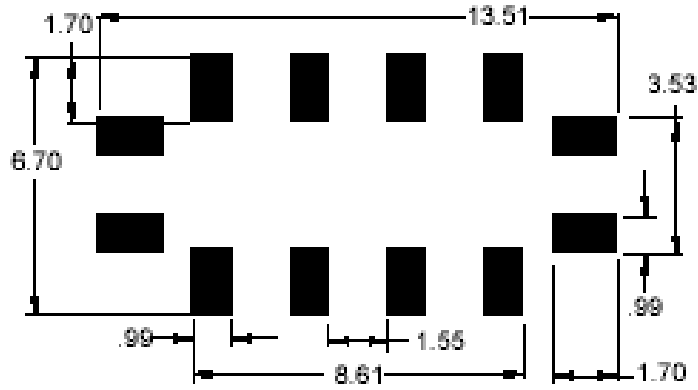

Unit: mm

**H. PACKING:**

**1. REEL DIMENSION**

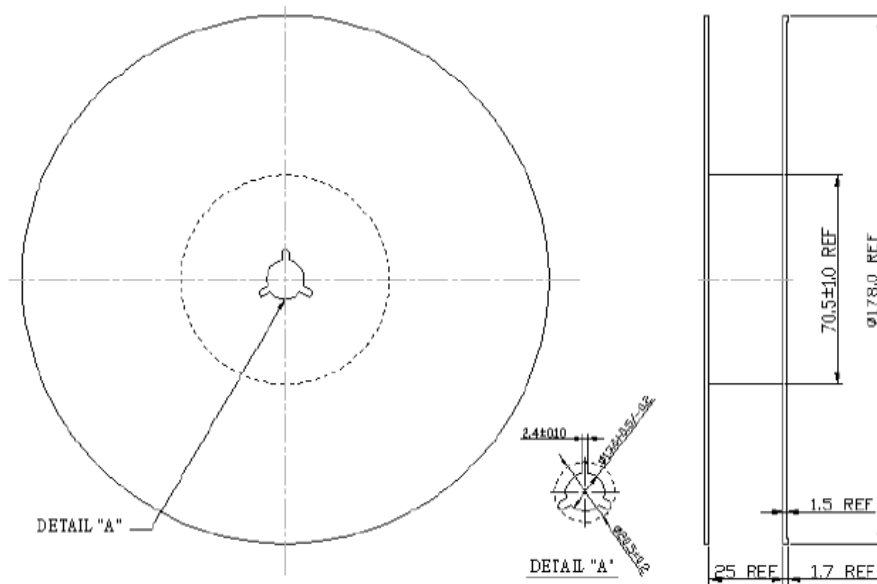

Unit: mm

## 2. TAPE DIMENSION

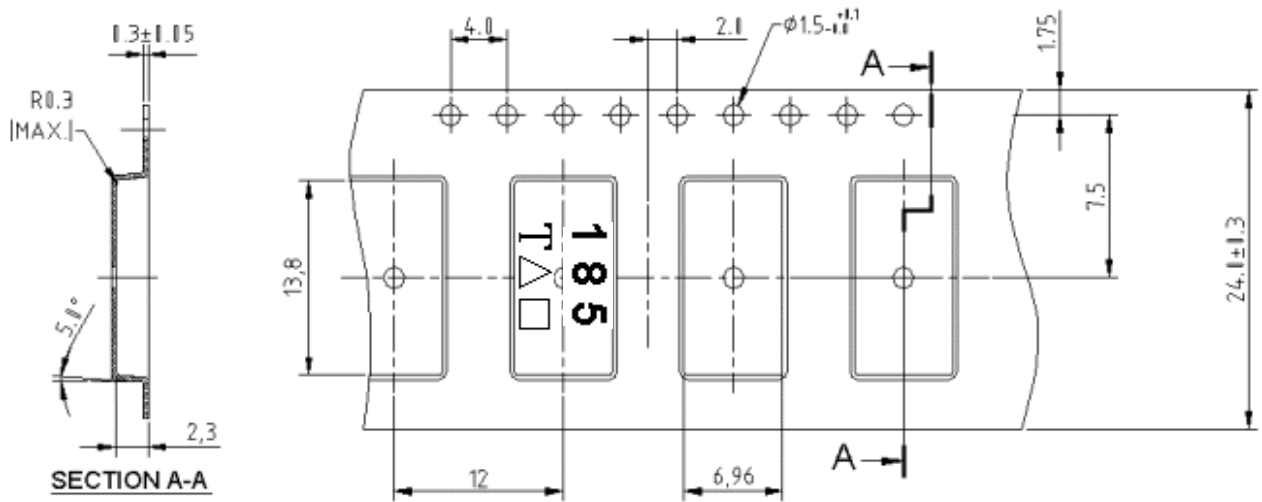

Unit: mm

## I. RECOMMENDED REFLOW PROFILE :

