



TAI-SAW TECHNOLOGY CO., LTD.

No. 3, Industrial 2nd Rd., Ping-Chen Industrial District,
Taoyuan, 324, Taiwan, R.O.C.

TEL: 886-3-4690038 FAX: 886-3-4697532

E-mail: tstsales@mail.taisaw.com Web: www.taisaw.com

Product Specifications Approval Sheet

Product Description: 46.3 MHz 21MHz BW SMD 7.0 x 5.0 mm SAW IF Filter

TST Parts No.: TB1166A

Customer Parts No.: _____

Customer signature required
Company: _____
Division: _____
Approved by : _____
Date: _____

Checked by: _____ Kazuma Lee 

Approval by: _____ Bob Chau 

Date: _____ 07 / 04 / 2014

1. Customer signed back is required before TST can proceed with sample build and receive orders.
2. Orders received without customer signed back will be regarded as agreement on the specifications.
3. Any specifications changes must be approved upon by both parties and a new revision of specifications shall be released to reflect the changes.



TAI-SAW TECHNOLOGY CO., LTD.

No.3, Industrial 2nd Rd., Ping-Chen Industrial District,
Taoyuan, Taiwan, R.O.C.

TEL: 886-3-4690038 FAX: 886-3-4697532

E-mail: tstsales3@mail.taisaw.com Web: www.taisaw.com

SAW Filter 46.3MHz 21MHz BW (SMD 7.0x5.0 mm)

MODEL NO.: TB1166A

REV. NO.1

A. MAXIMUM RATING:

1. Operating temperature range: -55°C to 85°C
2. Storage temperature range: -55°C to 85°C
3. Input Power Level : 10 dBm
4. Maximum DC Voltage : 10V

RoHS Compliant
Lead free
Lead-free soldering

Electrostatic Sensitive Device

B. Characteristics :

Ambient Temperature : 25°C

Item	Unit	Min.	Type.	Max.
Center frequency, F_c	MHz	-	46.3	-
Insertion Loss, IL	dB	-	27	29
3dB Bandwidth	MHz	21.0	22.7	-
35dB Bandwidth	MHz	-	27	-
Passband Ripple F _c +/- 9.0MHz	dB	-	1.0	1.5
Absolute group Delay	us	-	0.75	-
Group Delay variation F _c +/- 9.0MHz	ns	-	90	-
Attenuation (Reference level from minimum Insertion loss)				
62.3MHz~182.3MHz	dB	13	16.5	-
182.3MHz~500MHz	dB	40	43	-
Temperature Coefficient	ppm/°C	-	-94	-
Source Impedance	Ohm	-	50	-
Load Impedance	Ohm	-	50	-

C. Frequency Characteristics :

(1) Wide band Response:

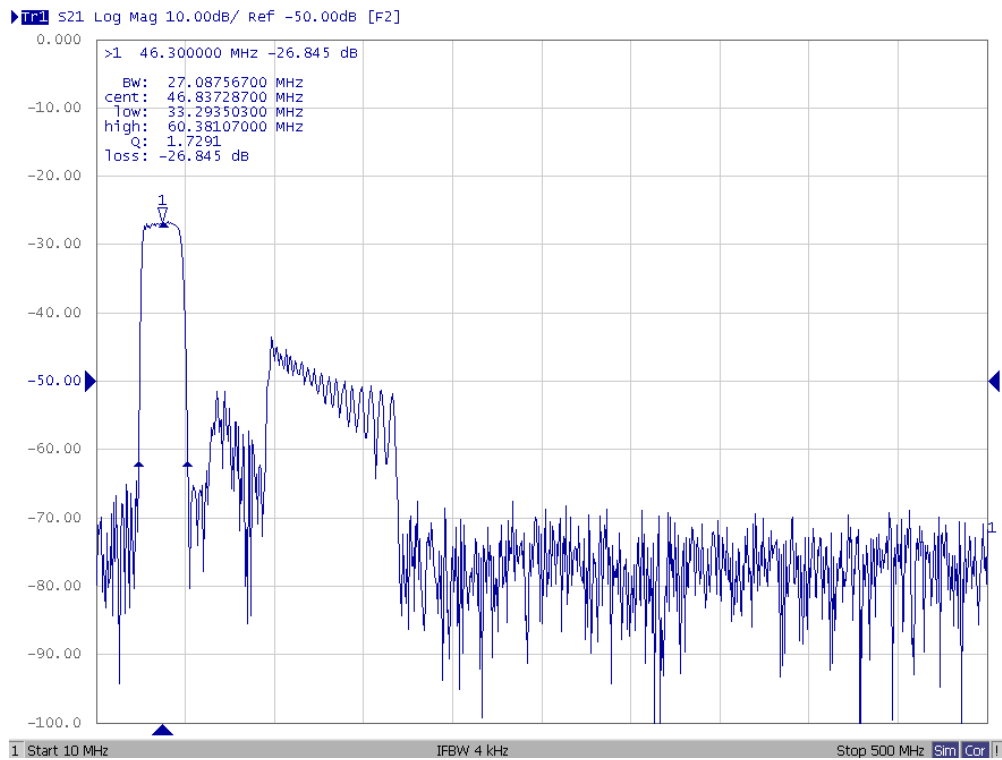

Fig1. Horizontal: 50MHz/Div Vertical: 10dB/Div

(2) Pass band Response and Group Delay Response:

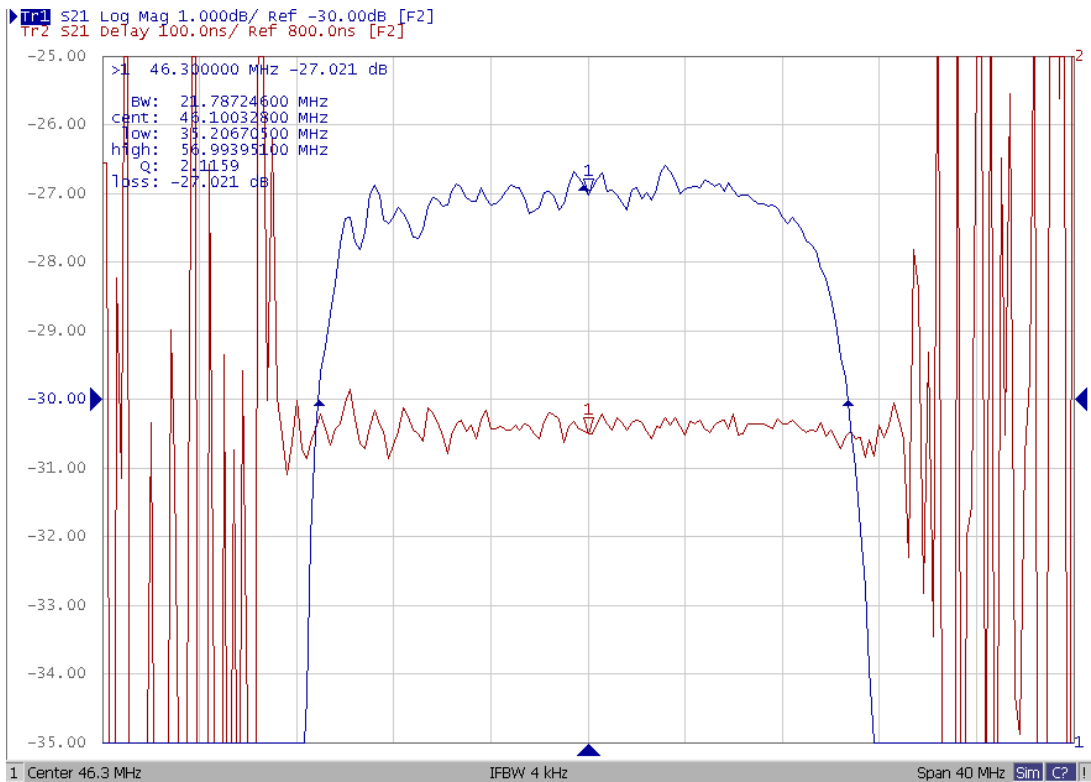
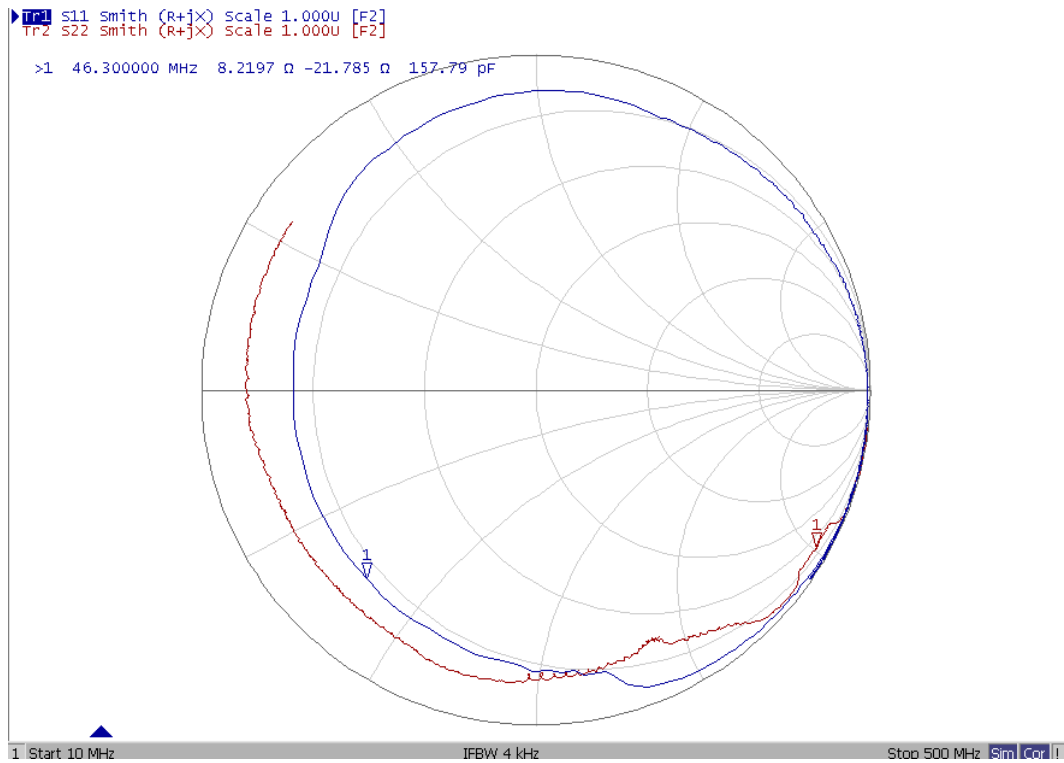
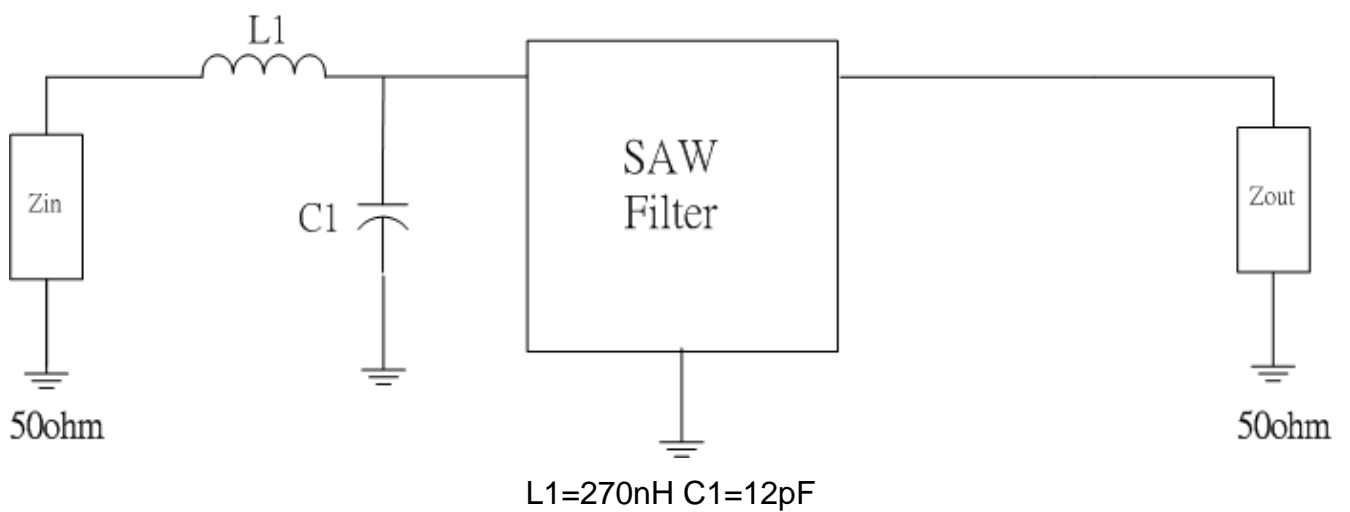

Fig2. Horizontal: 4MHz/Div Vertical: 1dB/Div
Vertical: 100ns/Div

(3) Smith Chart



D. Matching Circuit:



E. Outline Drawing:

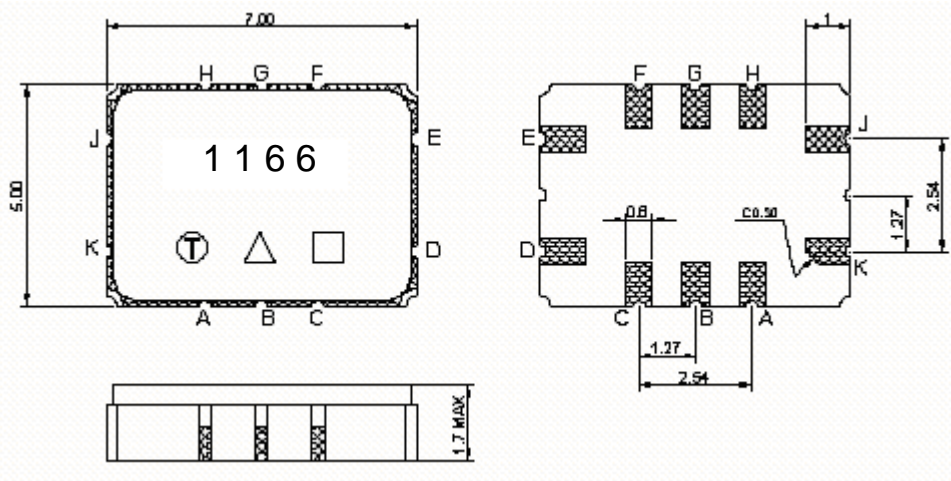

- Pin J –RF input
- Pin K –RF input ground
- Pin D –RF output
- Pin E –RF output ground
- Pin A,B,C,F,G,H - Ground
- : Week Code
- Unit : mm
- △ : Product / Year Code

Year	2013 2017	2014 2018	2015 2019	2016 2020
Product Code	B	b	<u>B</u>	<u>b</u>

Week Code Table

WK01	WK02	WK03	WK04	WK05	WK06	WK07	WK08	WK09	WK10	WK11	WK12	WK13
A	B	C	D	E	F	G	H	I	J	K	L	M
WK14	WK15	WK16	WK17	WK18	WK19	WK20	WK21	WK22	WK23	WK24	WK25	WK26
N	O	P	Q	R	S	T	U	V	W	X	Y	Z
WK27	WK28	WK29	WK30	WK31	WK32	WK33	WK34	WK35	WK36	WK37	WK38	WK39
a	b	c	d	e	f	g	h	i	j	k	l	m
WK40	WK41	WK42	WK43	WK44	WK45	WK46	WK47	WK48	WK49	WK50	WK51	WK52
n	o	p	q	r	s	t	u	v	w	x	y	z

F. PCB Footprint:

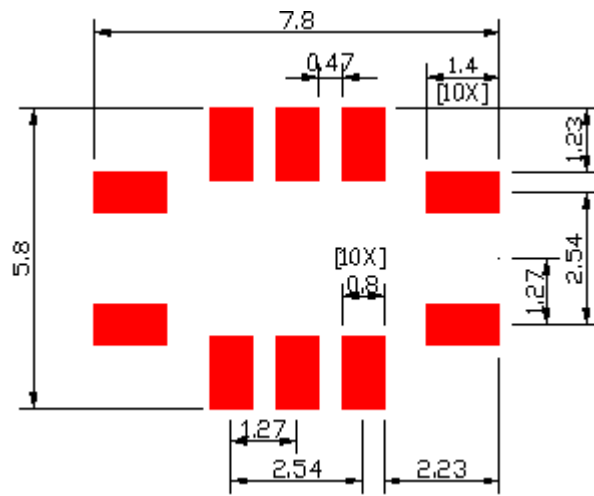

G. PACKING:

1. REEL DIMENSION (Please refer to FR-75D10 for packing quantity)

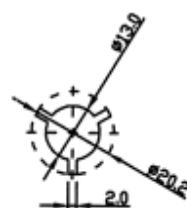
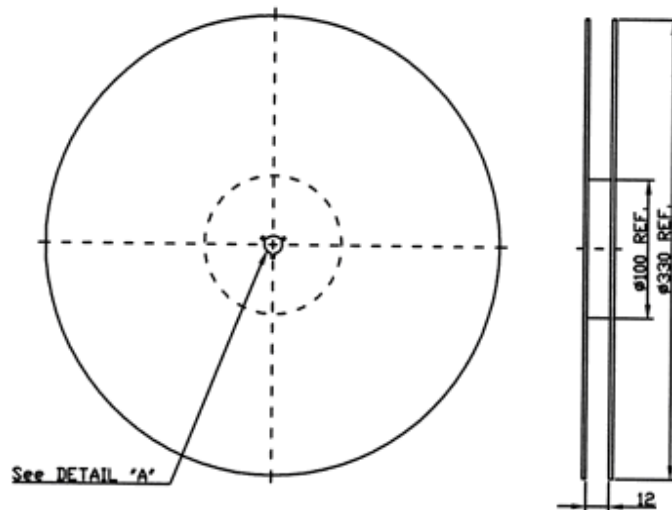

2. TAPE DIMENSION

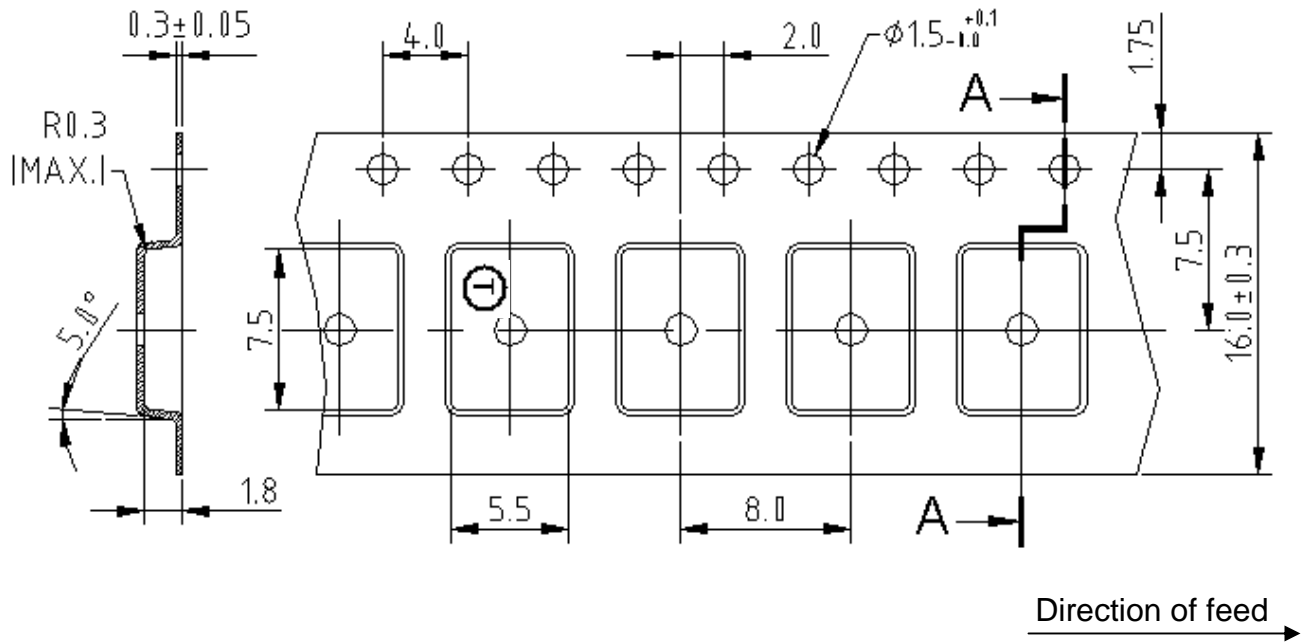

H. RECOMMENDED REFLOW PROFILE_:

