



TAI-SAW TECHNOLOGY CO., LTD.

No. 3, Industrial 2nd Rd., Ping-Chen Industrial District,
Taoyuan, 324, Taiwan, R.O.C.

TEL: 886-3-4690038 FAX: 886-3-4697532

E-mail: tstsales@mail.taisaw.com Web: www.taisaw.com

Product Specifications Approval Sheet

Product Description: SAW DPX 836.5/881.5 MHz LTE Band 5 SMD 1814

TST Part No.: TF0123B(This part is compliant with AEC-Q200)

Customer Part No.: _____

Customer signature required
Company: _____
Division: _____
Approved by : _____
Date: _____

Checked by: _____ Anne Chen 

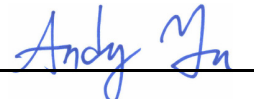
Approved by: _____ Andy Yu 

Date: _____ 2020/02/17

1. Customer signed back is required before TST can proceed with sample build and receive orders.
2. Orders received without customer signed back will be regarded as agreement on the specifications.
3. Any specifications changes must be approved upon by both parties and a new revision of specifications shall be released to reflect the change



TAI-SAW TECHNOLOGY CO., LTD.

No. 3, Industrial 2nd Rd., Ping-Chen Industrial District,
Taoyuan, 324, Taiwan, R.O.C.

TEL: 886-3-4690038 FAX: 886-3-4697532

E-mail: tstsales@mail.taisaw.com Web: www.taisaw.com

SAW DPX 836.5/881.5 MHz LTE Band 5 SMD 1814 (25 MHz BW)

MODEL NO.:TF0123B

REV.No.:2.0

A. MAXIMUM RATING:

1. Operating temperature range: -40 °C to +85 °C
2. Storage temperature range: -55 °C to +125 °C
3. Input power : 29dBm (Ta=+50deg C,50000h,CW)
4. Maximum DC Voltage: +/-3 V
5. Moisture Sensitivity Level: Level 3
- 6.ESD 50V(MM) 100V(HBM)

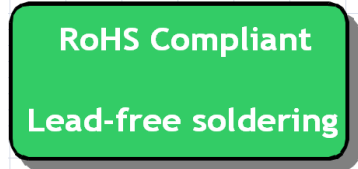

Electrostatic Sensitive Device (ESD)

B. ELECTRICAL CHARACTERISTICS:

Terminating impedance (Tx Port): 50 Ω(Single-ended)

Terminating impedance (Rx Port): 50 Ω (Single-ended)

Terminating impedance (Ant Port): 50//6.8nH Ω (Single-ended)

Tx to ANT (f_{T0}=836.5 MHz)

Parameters Description		Unit	Min	Typ	Max	Remarks
Insertion Loss	824~849MHz	dB(*1)	-	1.4	1.9	
Amplitude ripple	824~849MHz	dB	-	0.3	1.2	
VSWR	ANT	-	-	1.6	2.0	
	Tx	-	-	1.9	2.2	
Attenuation:						
DC~750 MHz		dB	25	40	-	
779~804 MHz		dB	30	45	-	
860~870 MHz		dB	3	7	-	
869~894 MHz		dB	52	58	-	
1574~1577 MHz		dB	40	51	-	
1648~1698 MHz		dB	40	53		
2472~2547 MHz		dB	30	54		

ANT to Rx (f_{T0}=881.5 MHz)

Parameters Description		Unit	Min	Typ	Max	Remarks
Insertion Loss	869~894 MHz	dB(*1)	-	1.7	2.3	
Amplitude ripple	869~894 MHz	dB	-	0.4	1.3	
VSWR	ANT	869~894 MHz	-	1.7	2.0	
	Rx		-	1.7	2.0	
Attenuation:						
779~804 MHz		dB	50	57	-	
824~849 MHz		dB	50	60	-	

Tx to Rx

Isolation	824~849 MHz	dB	55	58	-	
	869~894 MHz	dB	54	59	-	

(*1) Specification of insertion loss excludes loss that comes from the test board.

C. FREQUENCY CHARACTERISTICS:

Tx to Ant

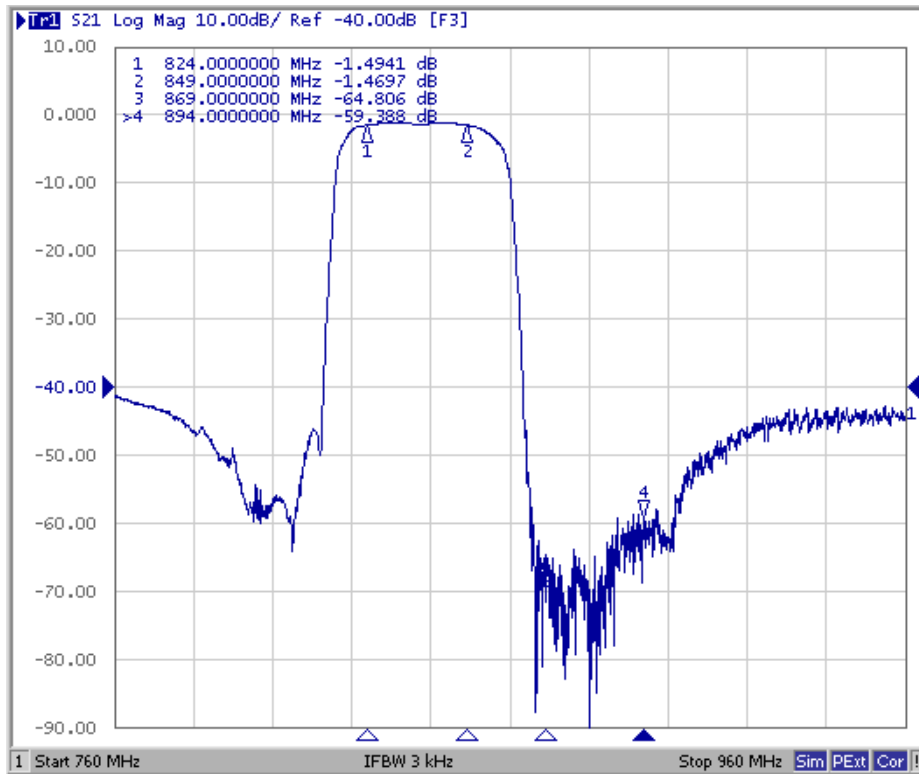

Ant to Rx

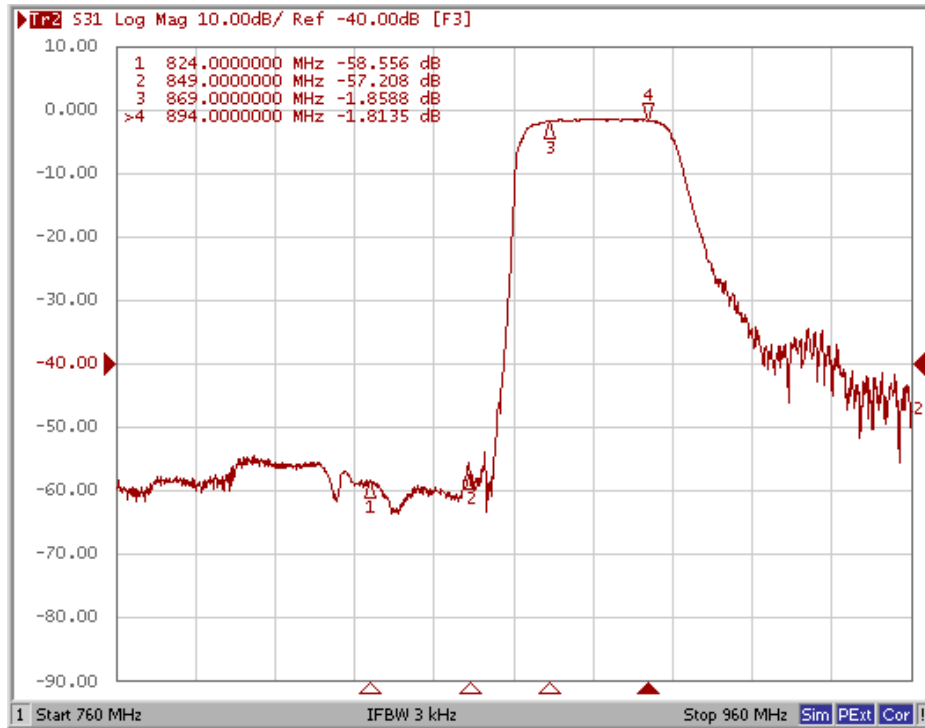

These data **exclude** loss that comes from the test board.

Tx to Ant ,Ant to Rx

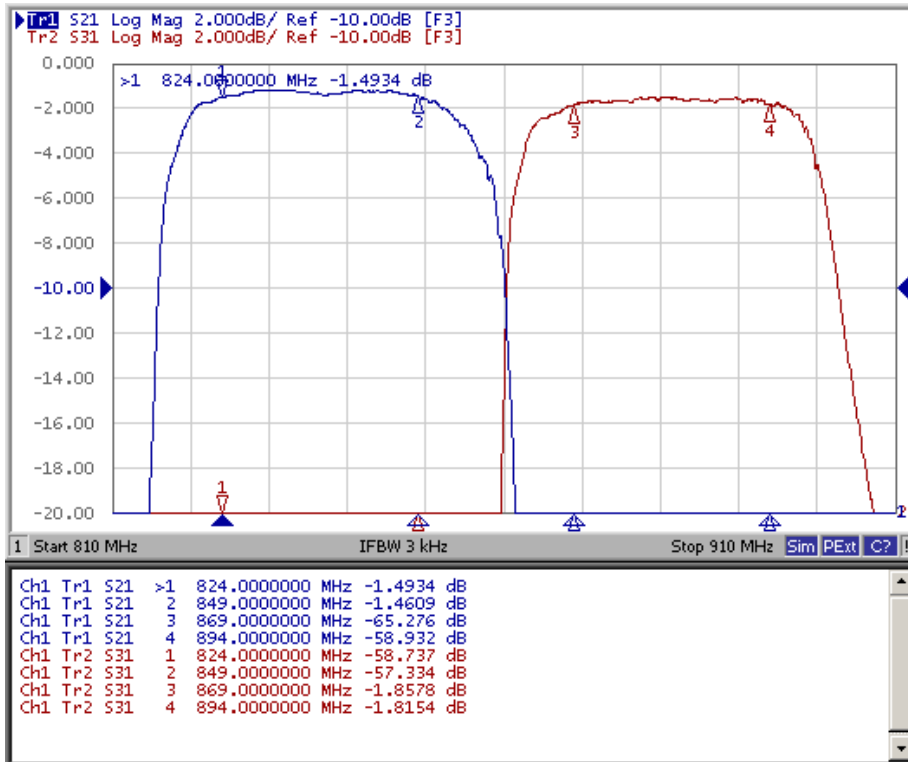

Tx to Rx Isolation

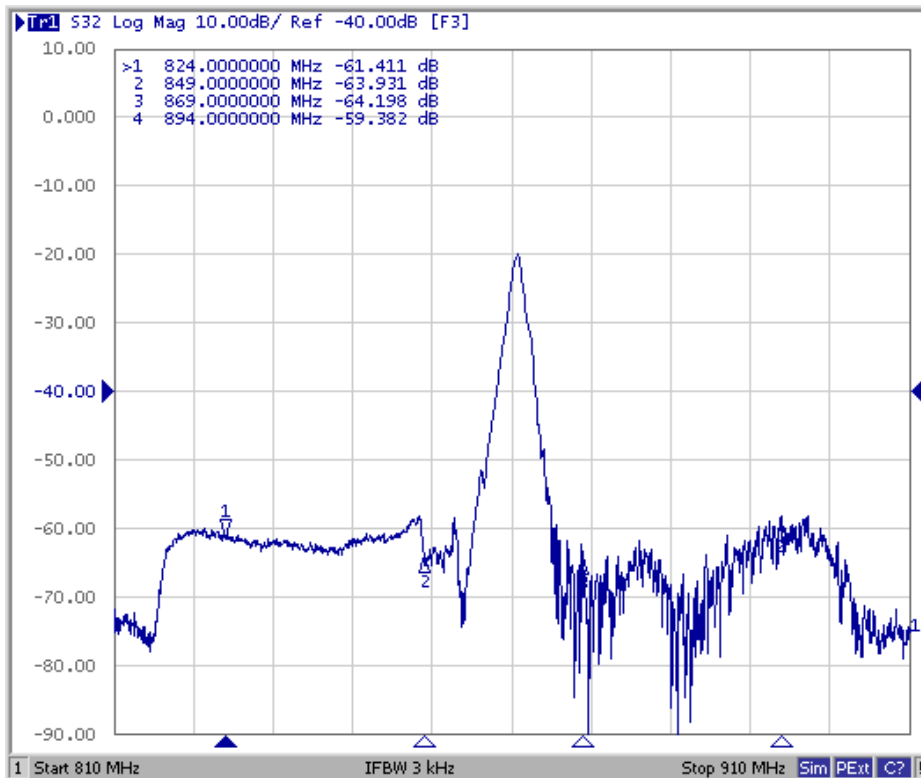

These data **exclude** loss that comes from the test board

Tx Port

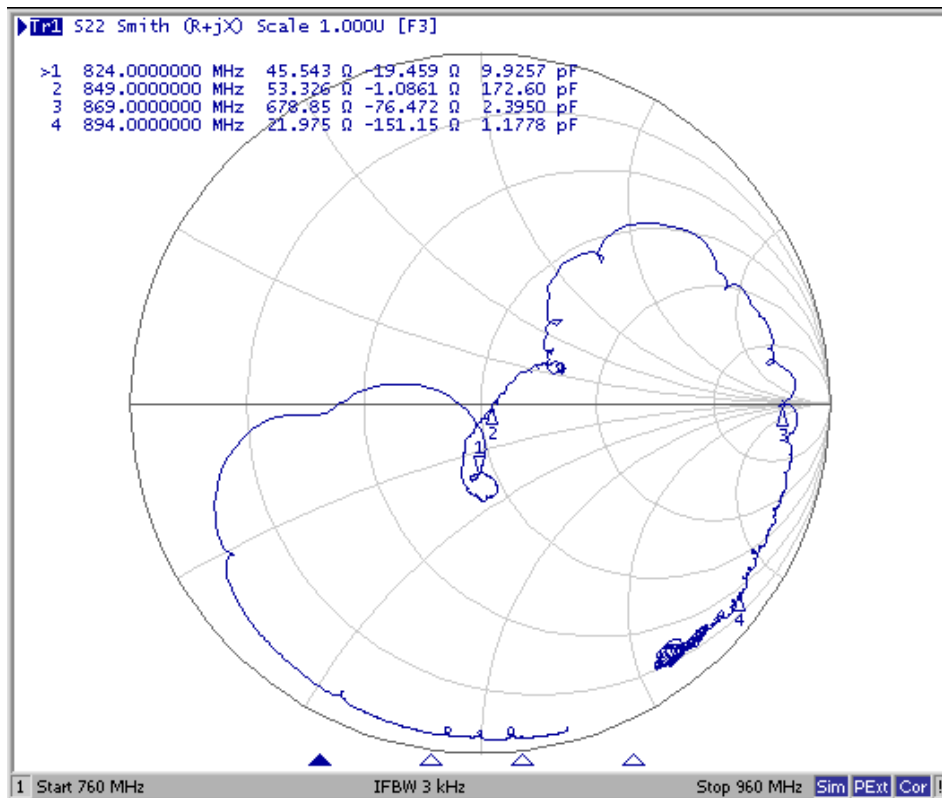
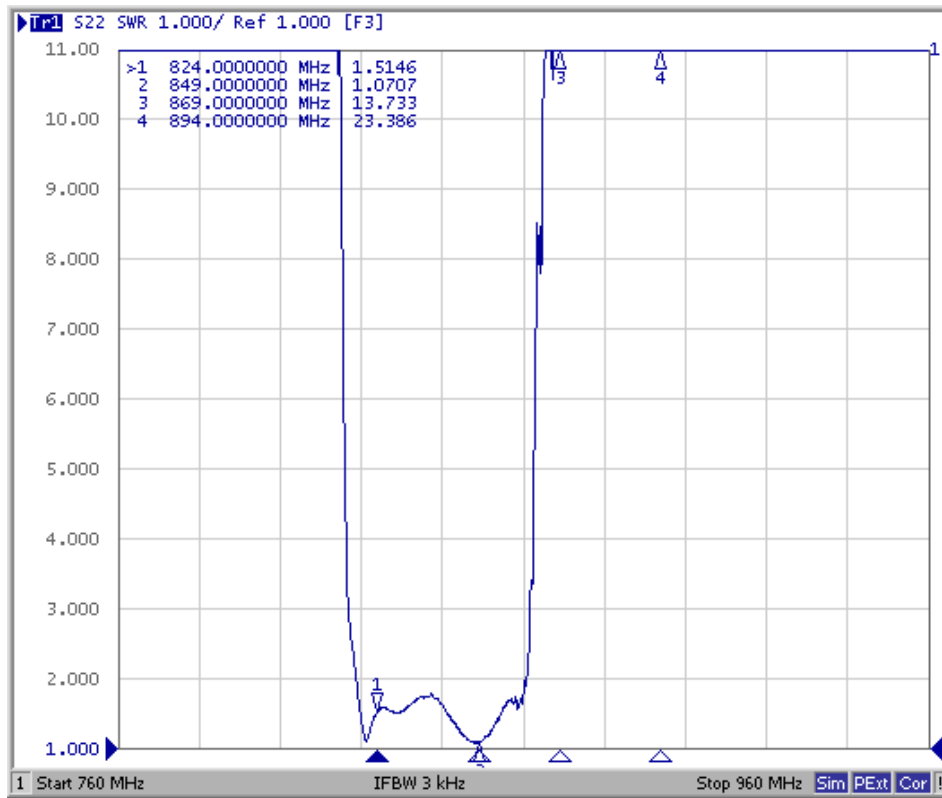

Rx Port

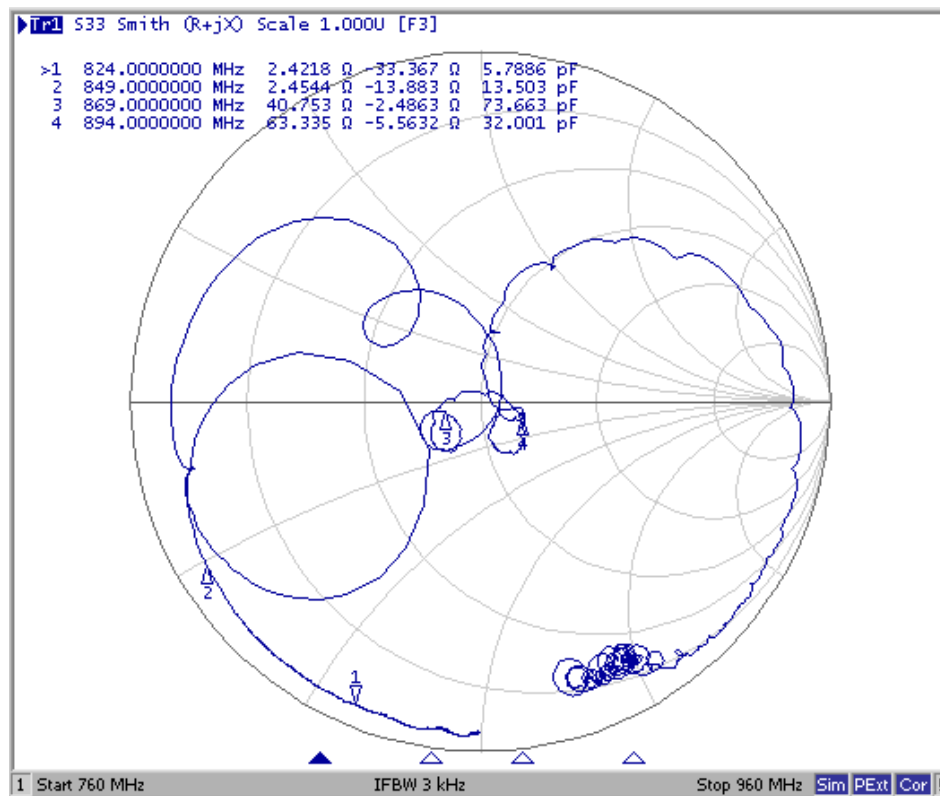
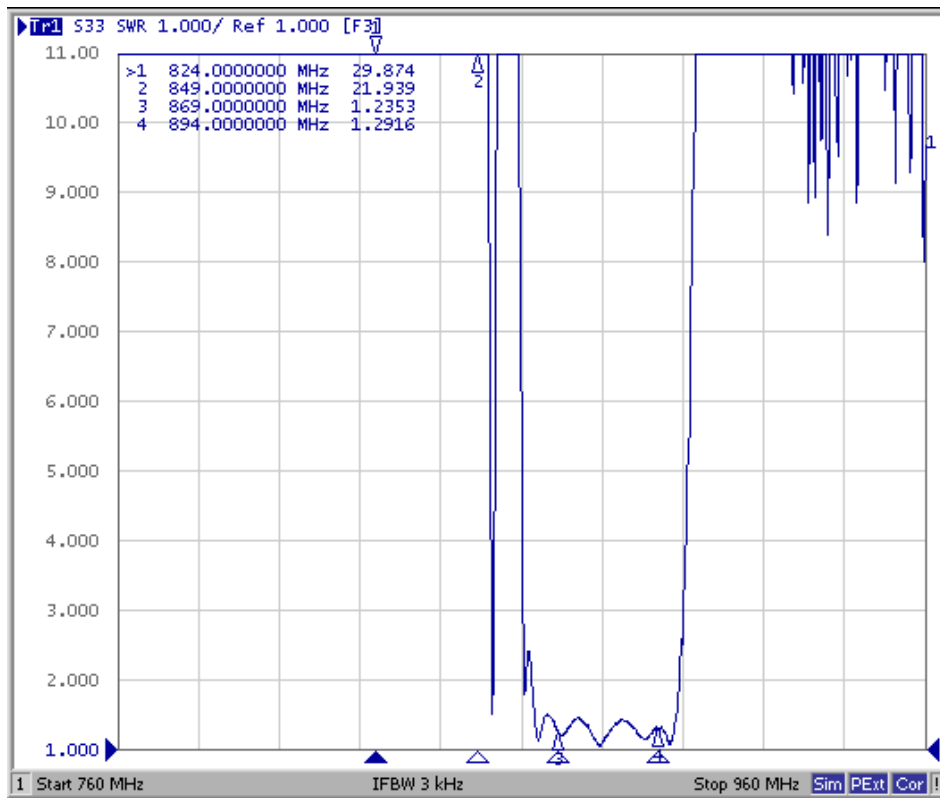

Ant Port

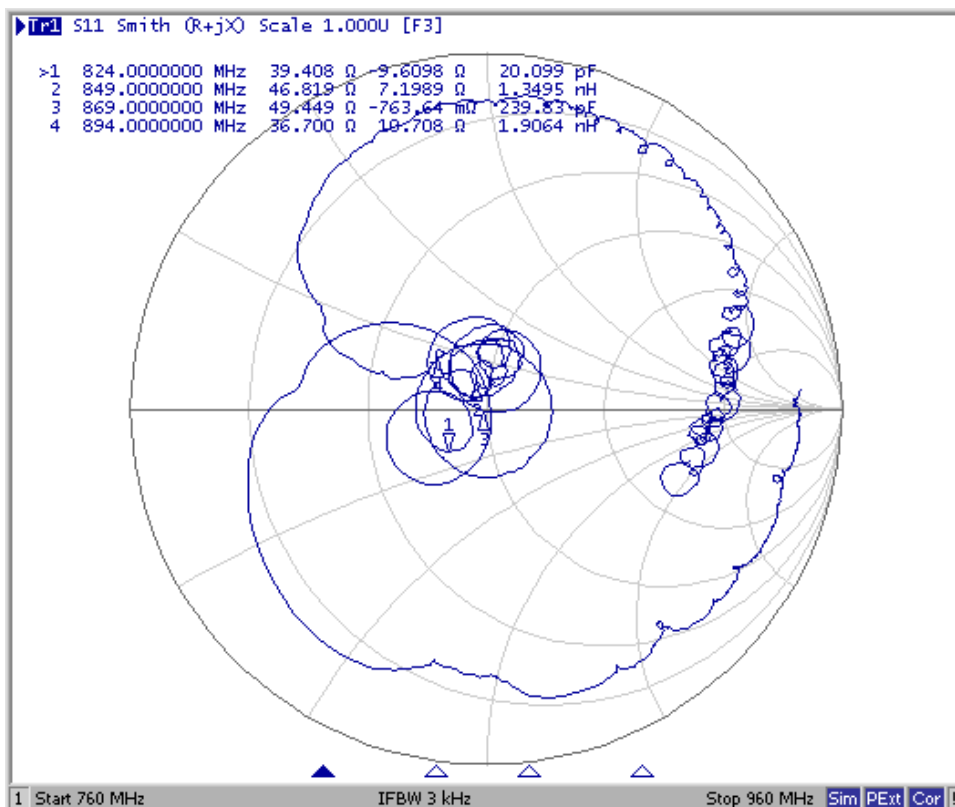
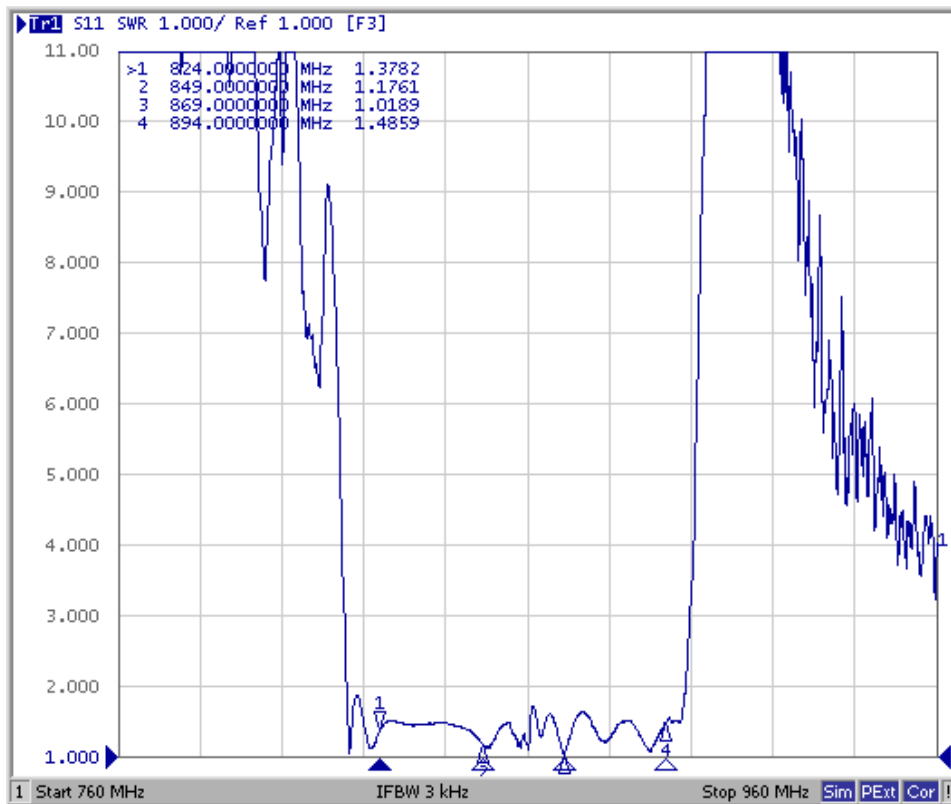

Tx to Ant (Wide span)

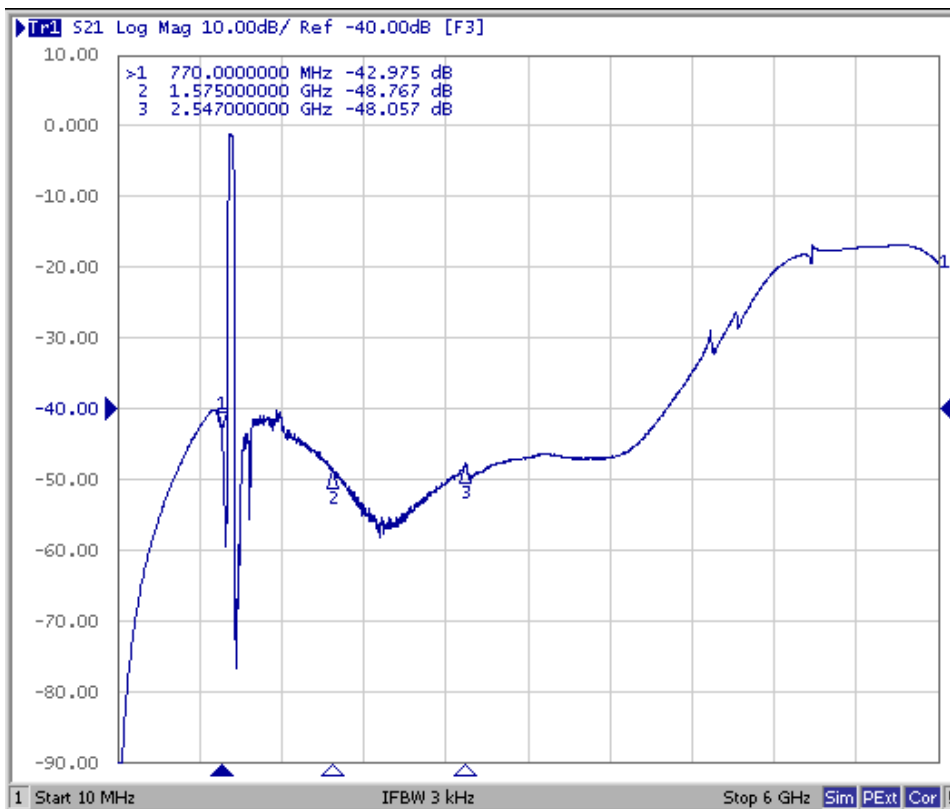

Ant to Rx (Wide span)

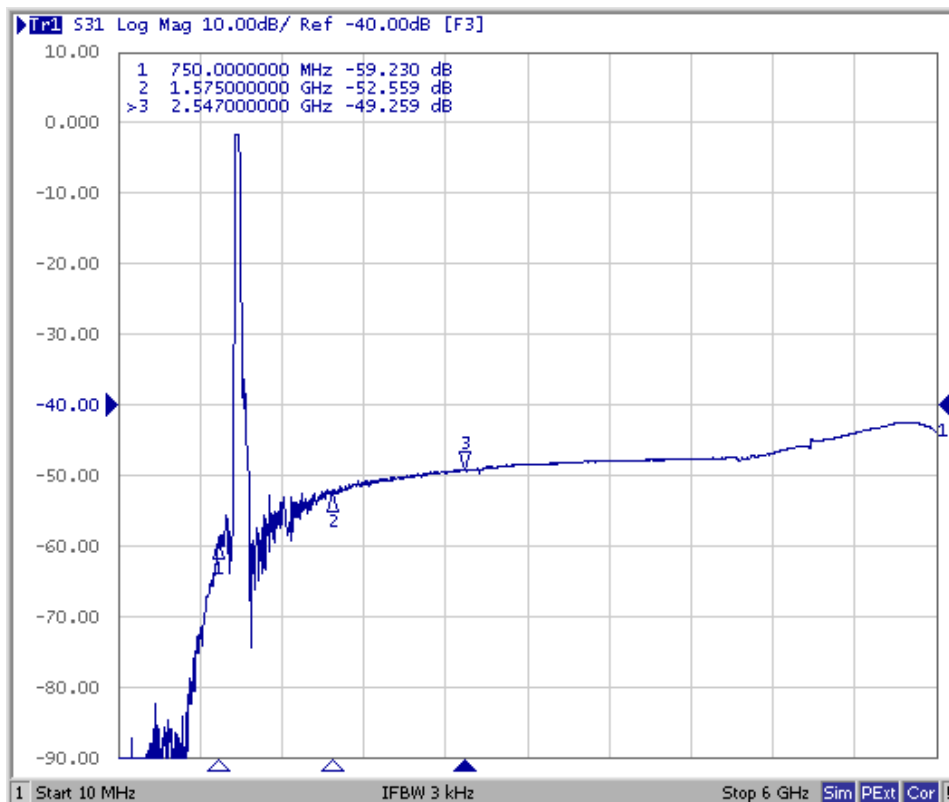

D .OUTLINE DRAWIN:

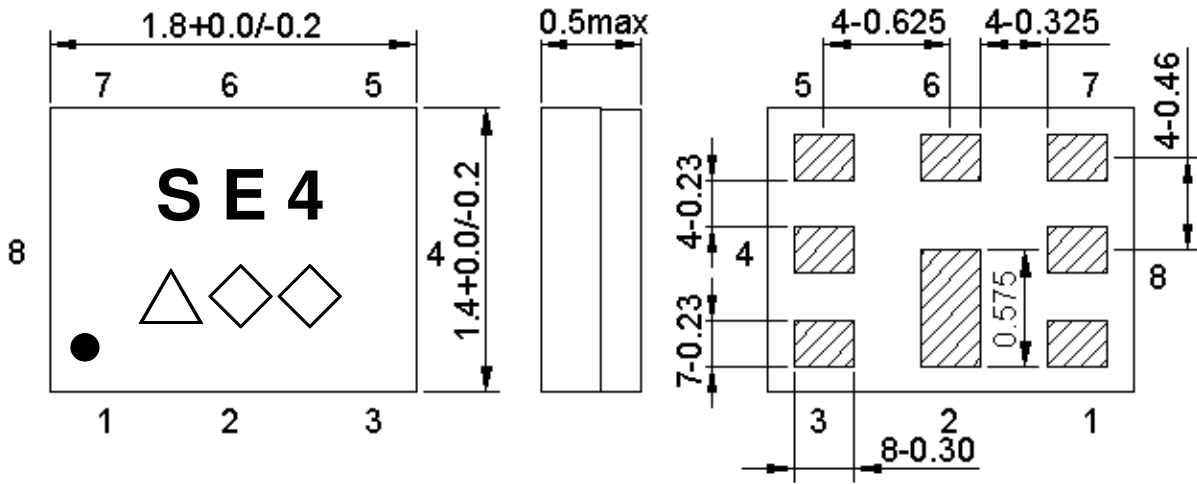

Not Specified Tolerance : ± 0.05 mm
 Coplanarity : 0.1 mm max.
 1 to 8 : Pin No.
 Unit : mm

Marking name : **SE4**

△: Date code(2016 May → s ,....., 2019 Dec→m.)

◇◇: Lot Code.

Product Date Code. Follow below table.

Year	Jan	Feb	Mar	Apr	May	Jun	Jul	Aug	Sep	Oct	Nov	Dec
2016	n	p	q	r	s	t	u	v	w	x	y	z
2017	A	B	C	D	E	F	G	H	J	K	L	M
2018	N	P	Q	R	S	T	U	V	W	X	Y	Z
2019	a	b	c	d	e	f	g	h	j	k	l	m
2020	n	p	q	r	s	t	u	v	w	x	y	z
2021	A	B	C	D	E	F	G	H	J	K	L	M

Pin Configuration:

Pin No.	Pin Name	Description
1	Rx	Receive Pin
2	GND	Ground Pin
3	Tx	Transmitter Pin
4	GND	Ground Pin
5	GND	Ground Pin
6	ANT	Antenna Pin
7	GND	Ground Pin
8	GND	Ground Pin

E. Evaluation Circuit

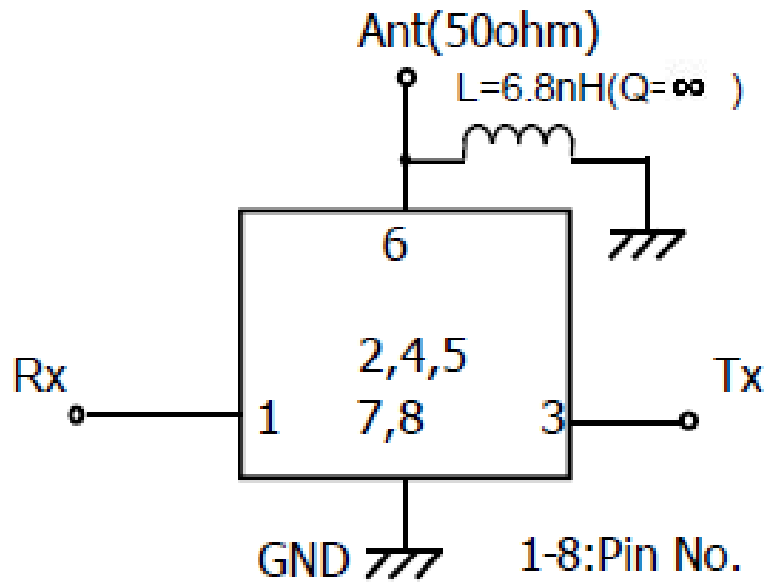

F. FOOTPRINT:

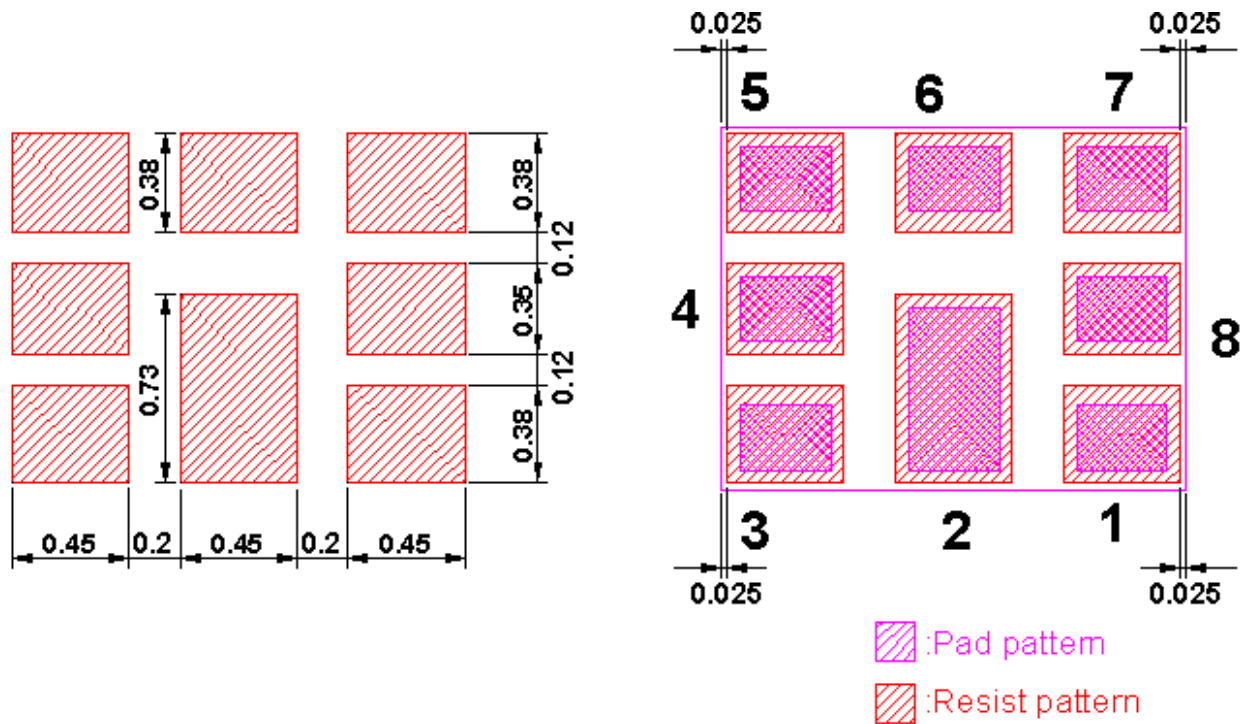

G. PACKING:

1. REEL DIMENSION

(Please refer to FR-75D10 for packing quantity)

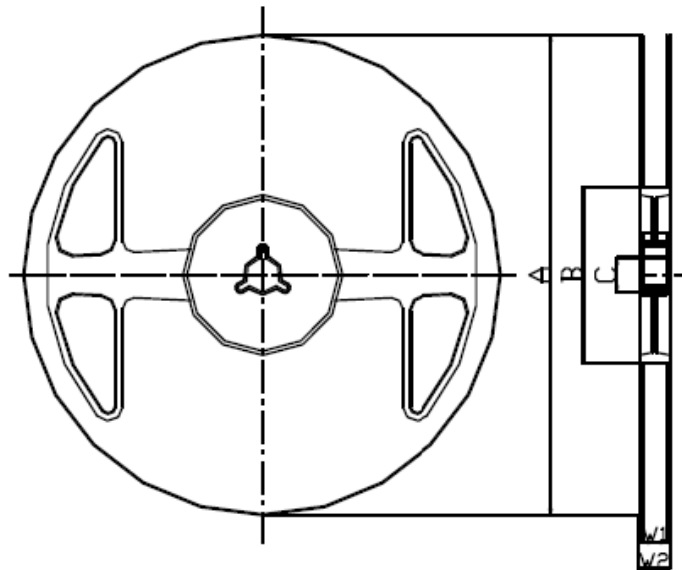

Materials of Reel

Material : Polystyrene + Carbon

Characteristics : Conforms to EIAJ-ET-7200A

Color : Black

Surface resistance (reference value) : $10^9\Omega/\text{sq}$ Max.

Unit : mm

Code	Quantity	A	B	C	W1	W2
Z	3,000 pcs	$\phi 180.0 +0.0/-1.5$	$\phi 66.0 +/-0.5$	$\phi 13.0 +/-0.2$	$9.0 +1.0/-0.0$	$11.4 +/-1.0$

2. TAPE DIMENSION

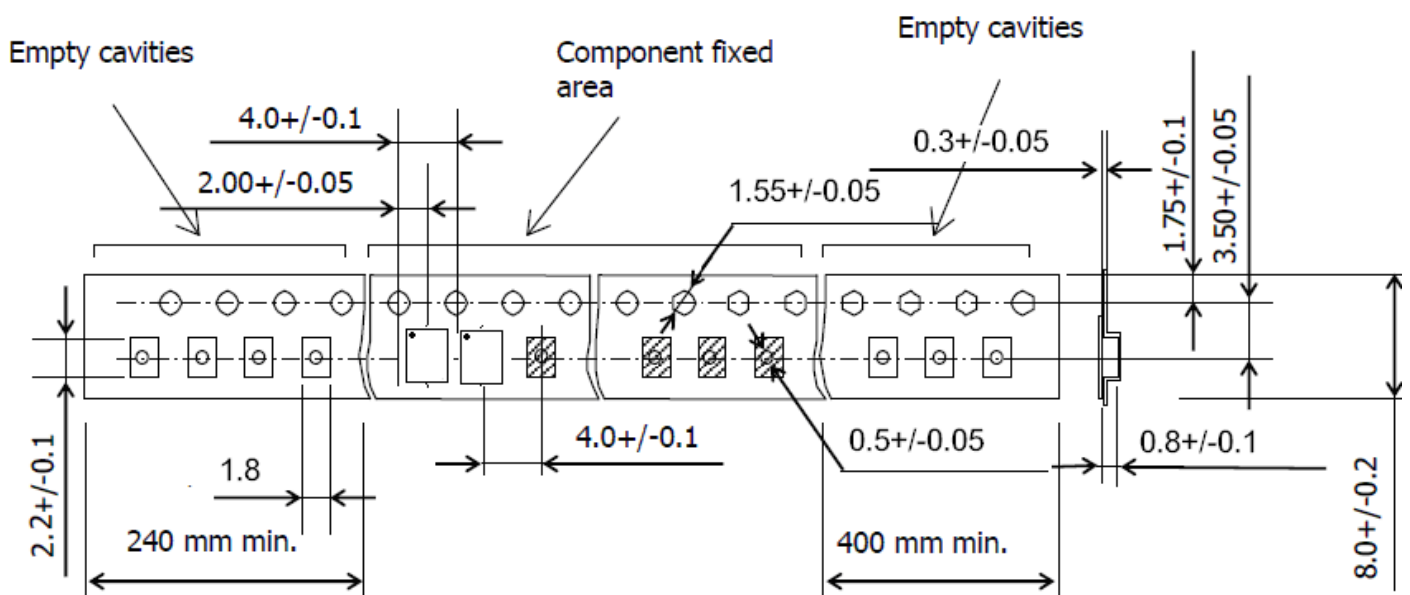

Unit : mm

Direction of feed

TAI-SAW TECHNOLOGY CO., LTD.

TST DCC
Release document

H. RECOMMENDED REFLOW PROFILE :

1. Preheating shall be fixed at 150~180°C for 60~90 seconds.
2. Ascending time to preheating temperature 150°C shall be 30 seconds min.
3. Heating shall be fixed at 220°C for 50~80 seconds and at 245~260°C peak (min. 10sec).
4. Time : 3 times.

