



TAI-SAW TECHNOLOGY CO., LTD.

No. 3, Industrial 2nd Rd., Ping-Chen Industrial District,
Taoyuan, 324, Taiwan, R.O.C.

TEL: 886-3-4690038 FAX: 886-3-4697532

E-mail: tstsales@mail.taisaw.com Web: www.taisaw.com

Product Specifications Approval Sheet

Product Description: SAW DPX 897.5/942.5 MHz LTE Band 8 SMD 1814

TST Part No.: TF0130A

Customer Part No.: _____

Customer signature required
Company: _____
Division: _____
Approved by : _____
Date: _____

Checked by: _____ Anne Chen 

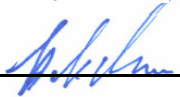
Approved by: _____ Bob Chau 

Date: _____ 2017, 04. 10

1. Customer signed back is required before TST can proceed with sample build and receive orders.
2. Orders received without customer signed back will be regarded as agreement on the specifications.
3. Any specifications changes must be approved upon by both parties and a new revision of specifications shall be released to reflect the change



TAI-SAW TECHNOLOGY CO., LTD.

No. 3, Industrial 2nd Rd., Ping-Chen Industrial District,
Taoyuan, 324, Taiwan, R.O.C.

TEL: 886-3-4690038 FAX: 886-3-4697532

E-mail: tstsales@mail.taisaw.com Web: www.taisaw.com

SAW DPX 897.5/942.5 MHz LTE Band 8 SMD 1814 (30.2 MHz BW)

MODEL NO.:TF0130A

REV.No.:2

A. MAXIMUM RATING:

1. Operating temperature range: -20 °C to +85 °C
2. Storage temperature range: -20 °C to +85 °C
3. Input power : 29dB (Ta=+50°C,10000h,WCDMA modulation)
4. Maximum DC Voltage: +/-3 V
5. Moisture Sensitivity Level: Level 1
6. ESD 50V(MM) 100V(HBM)

RoHS Compliant
Lead free
Lead-free soldering

Electrostatic Sensitive Device (ESD)

B. ELECTRICAL CHARACTERISTICS:

Terminating impedance (Tx Port): 50 Ω(Single-ended)

Terminating impedance (Rx Port): 100 Ω (Differential)

Terminating impedance (Ant Port): 50//7.5nH Ω(Q=∞) (Single-ended)

Tx to ANT (f_{T0}=897.5 MHz)

Parameters Description		Unit	Min	Typ	Max	Remarks
Insertion Loss	882.4~912.6MHz	dB(*1)	-	1.5	2.4(*2)	
	880~915MHz	dB(*1)		1.9	3.4	
Amplitude ripple	882.4~912.6MHz	dB	-	0.6	1.9	
	880~915MHz	v		1.0	2.9	
VSWR	ANT		-	-	2.0	2.6
	Tx		-	-	1.8	2.4

Attenuation:

927.4~957.6 MHz	dB	42(*2)	47	-	
1573.3~1605.9 MHz	dB	40	45	-	
1760~1830 MHz	dB	40	45	-	
2640~2745 MHz	dB	25	32	-	

ANT to Rx ($f_{T0}=942.5$ MHz)

Parameters Description		Unit	Min	Typ	Max	Remarks
Insertion Loss	927.4~957.6 MHz	dB(*1)	-	1.9	2.4(*2)	
	925~960 MHz	dB(*1)		2.1	3.1	
Amplitude ripple	927.4~957.6 MHz	dB	-	0.7	1.6	
	925~960 MHz	dB		0.9	2.3	
Amplitude balance	925~960 MHz	dB	-0.7	-0.1/+0.3	+0.7	
Phase balance	925~960 MHz	dB	-7	-1/+3	+7	
VSWR	ANT	-		1.9	2.3	
	Rx	-		2.0	2.4	
Attenuation:						
882.4~912.6 MHz		dB	48 (*2)	54	-	
2400~2500 MHz		dB	40	49	-	

Tx to Rx

Isolation	882.4~912.6MHz	dB	52(*2)	56	-	
	927.4~957.6 MHz	dB	47 (*2)	51	-	

(*1) Specification of insertion loss excludes loss that comes from the test board.

(*2) Integrated over +/-1.92MHz around the WCDMA channel center frequency

C.Evaluation Circuit

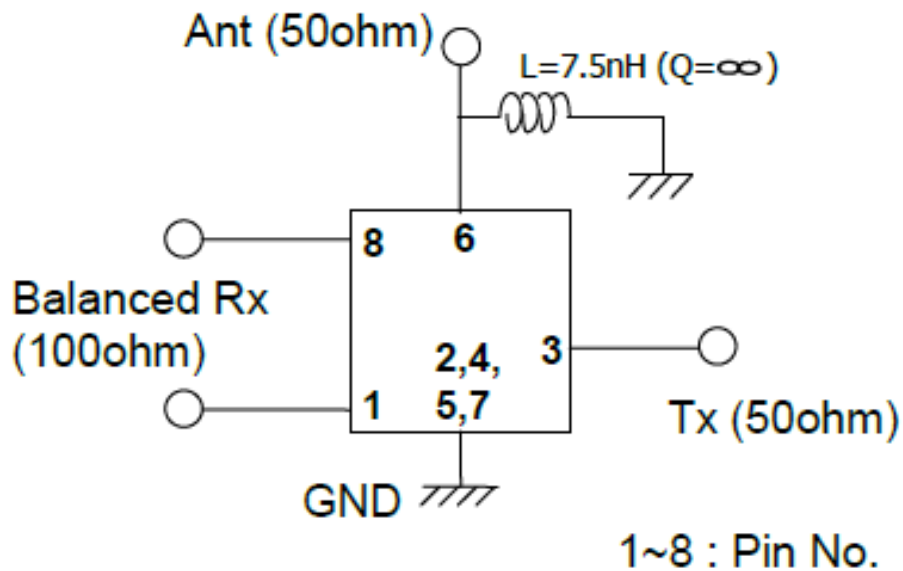
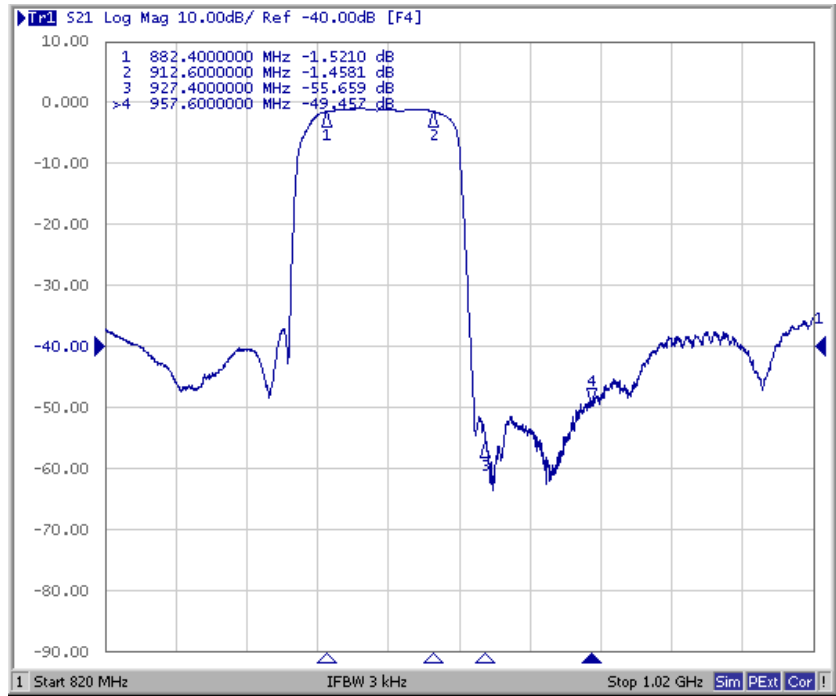

Figure 2. Evaluation Circuit

D. FREQUENCY CHARACTERISTICS:

Tx to Ant



Ant to Rx

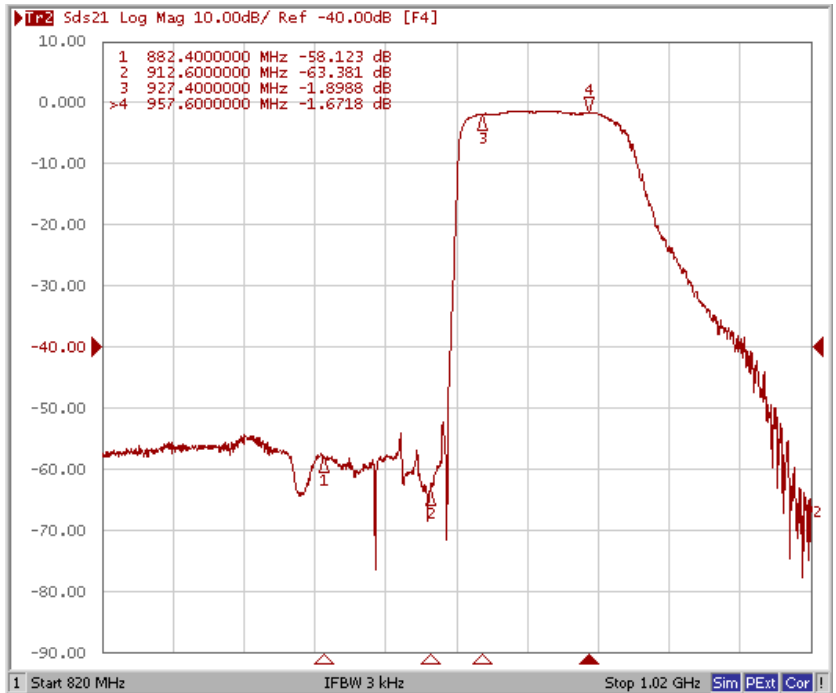

These data **exclude** loss that comes from the test board.

Tx to Ant ,Ant to Rx

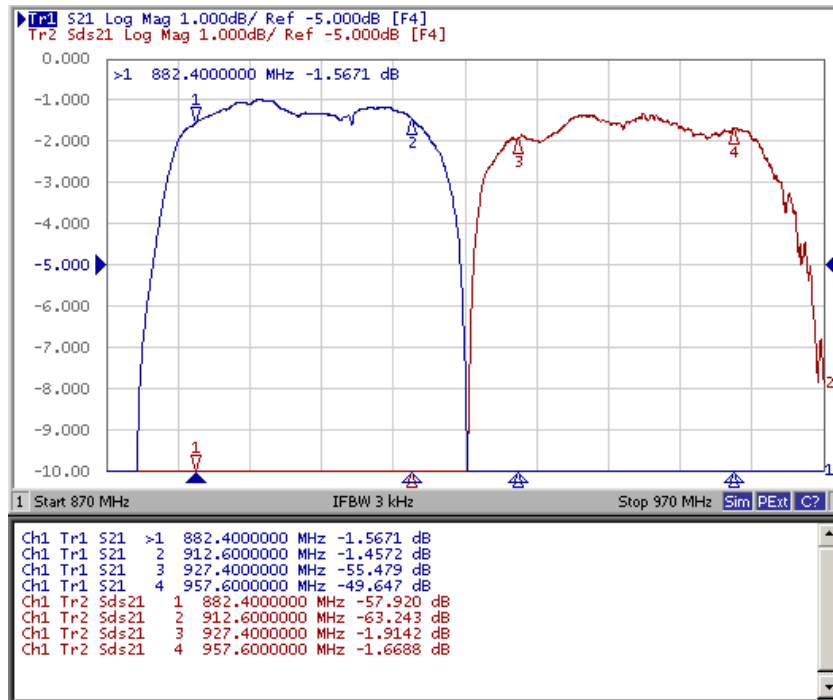

Tx to Rx Isolation

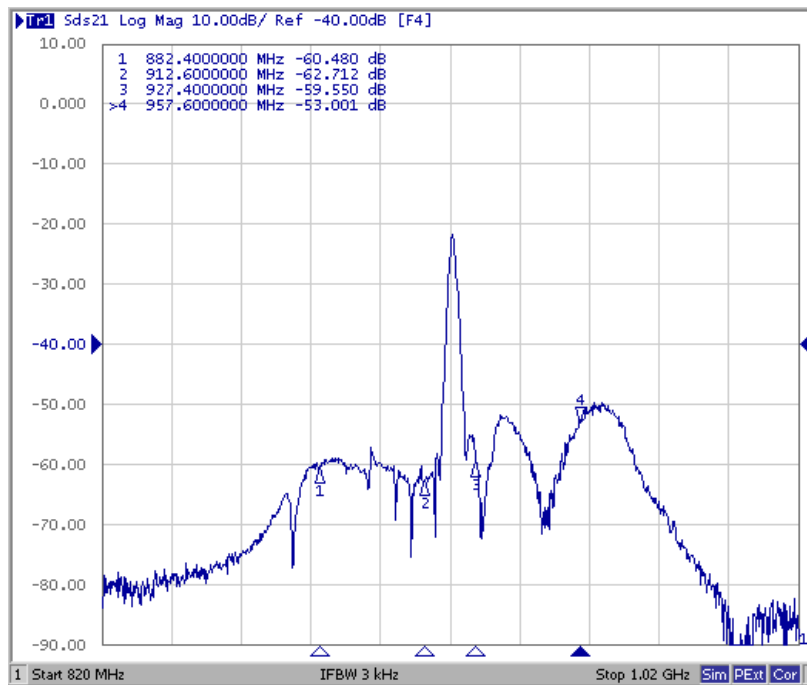

These data **exclude** loss that comes from the test board

Tx Port

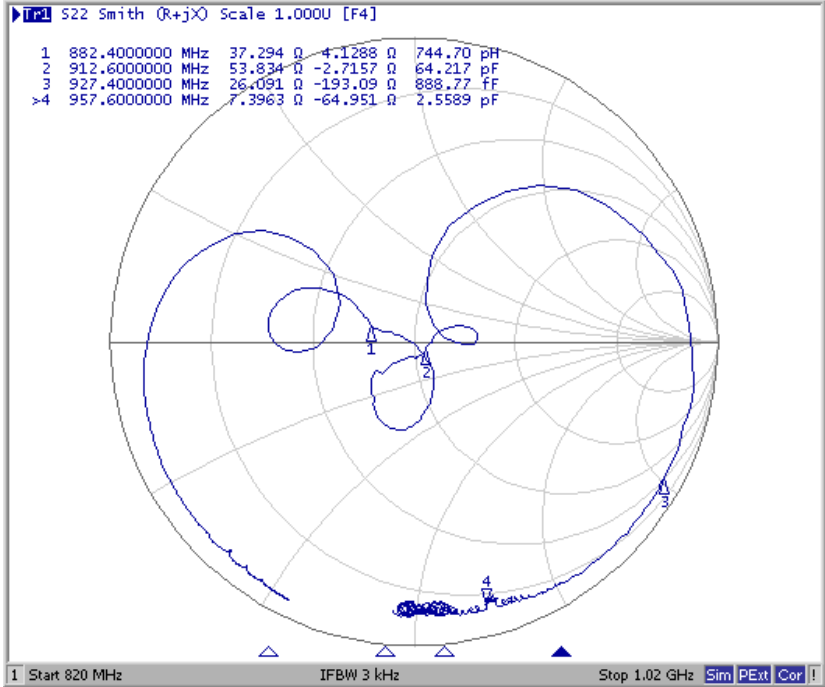
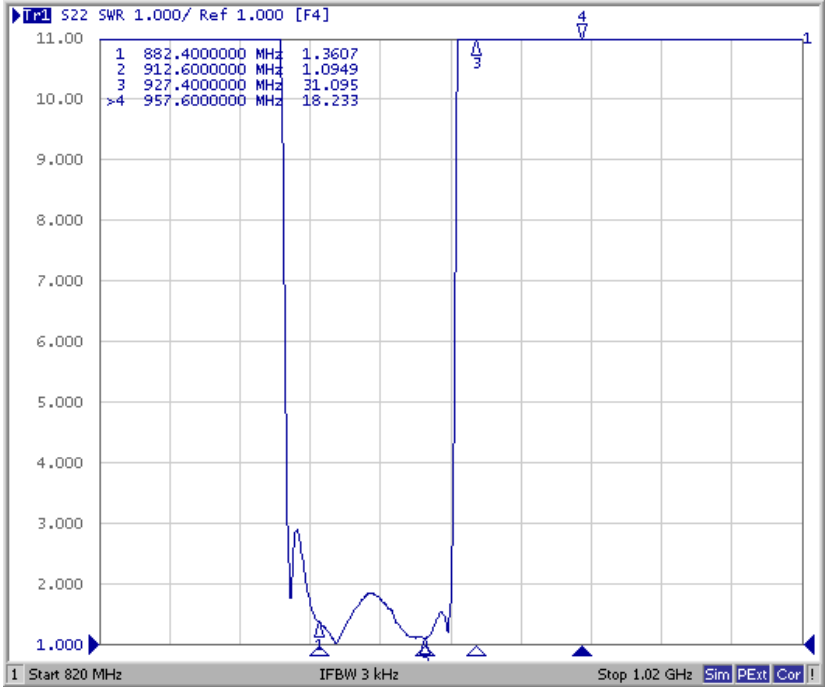

Rx Port

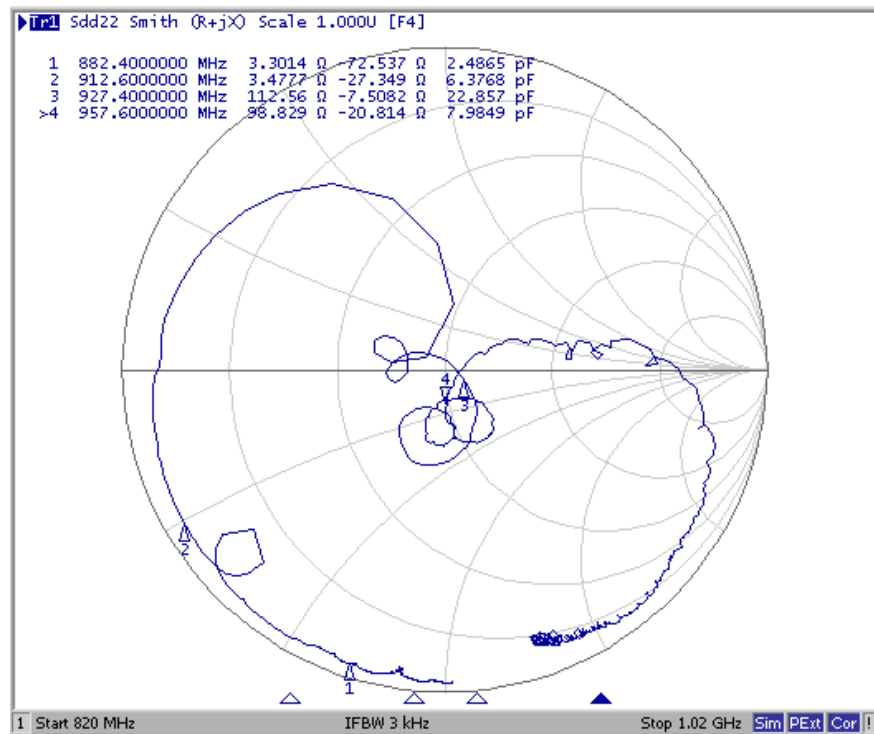
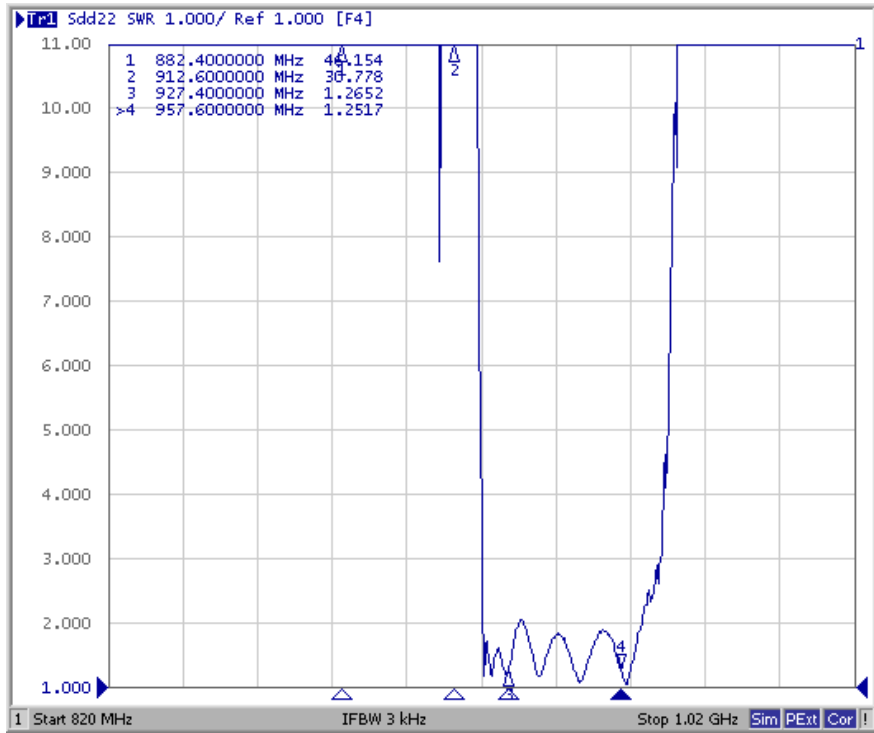

Ant Port

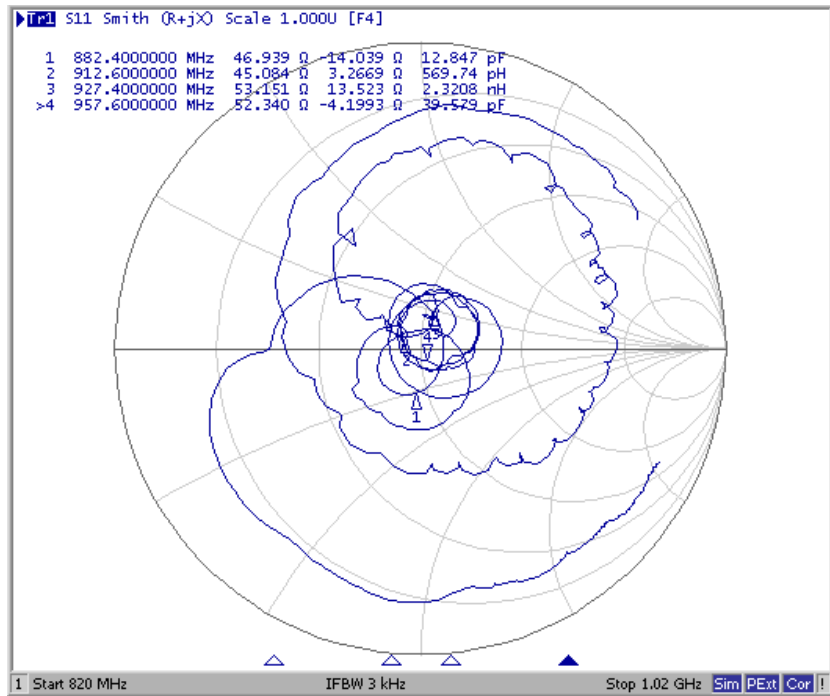
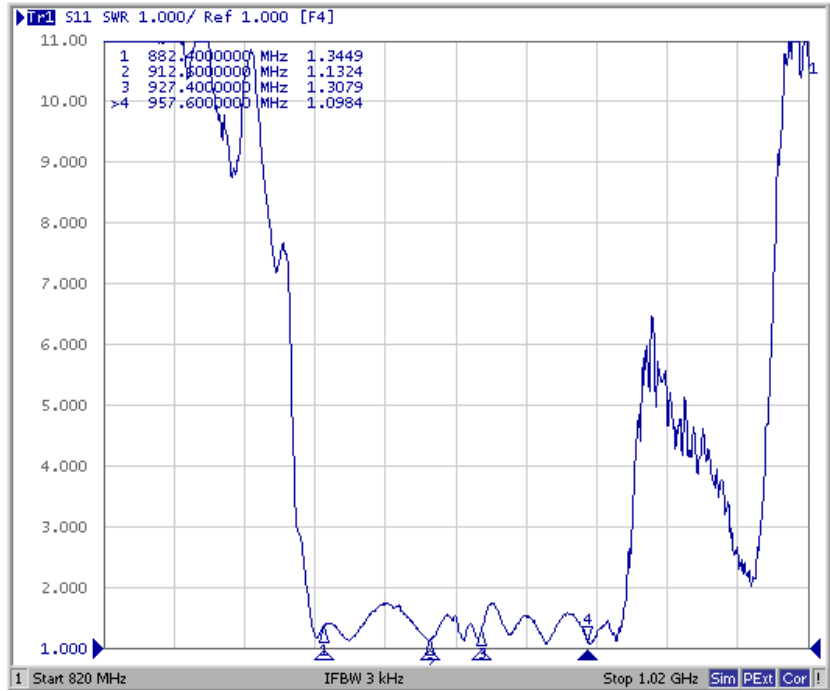

Ant to Rx (Amplitude balance)

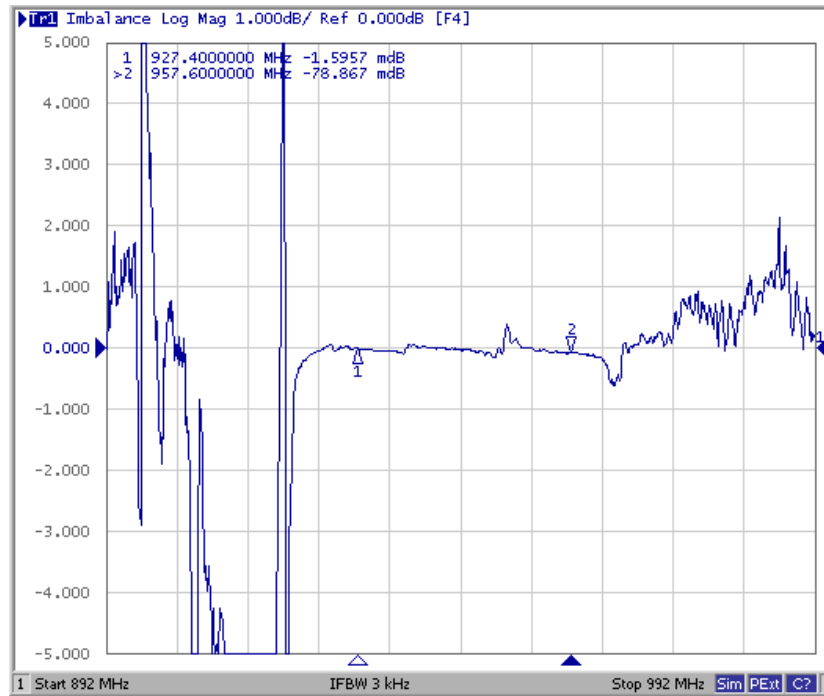

Ant to Rx (Phase balance)

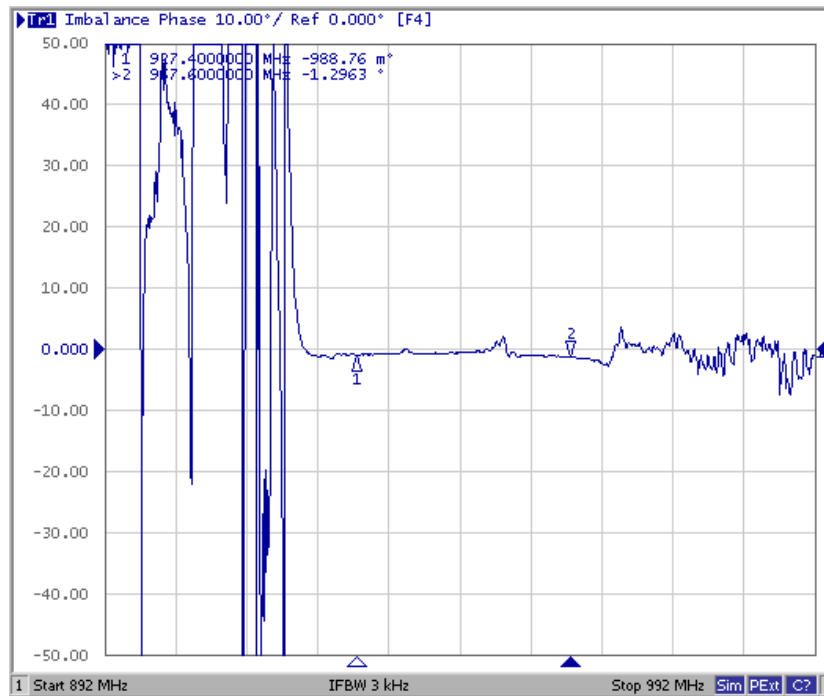

Tx to Ant (Wide span)

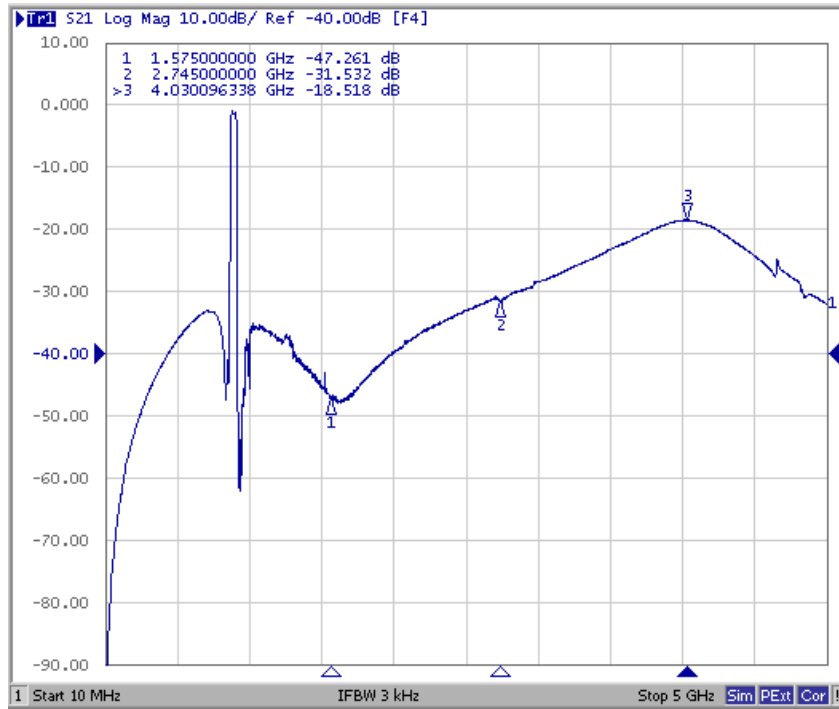

Ant to Rx (Wide span)

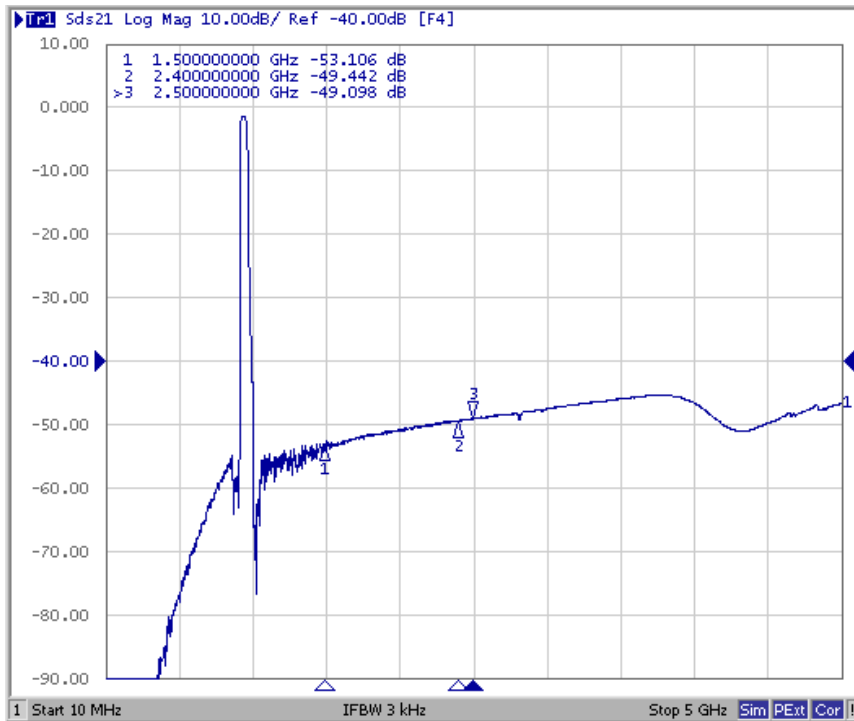

E. OUTLINE DRAWIN:

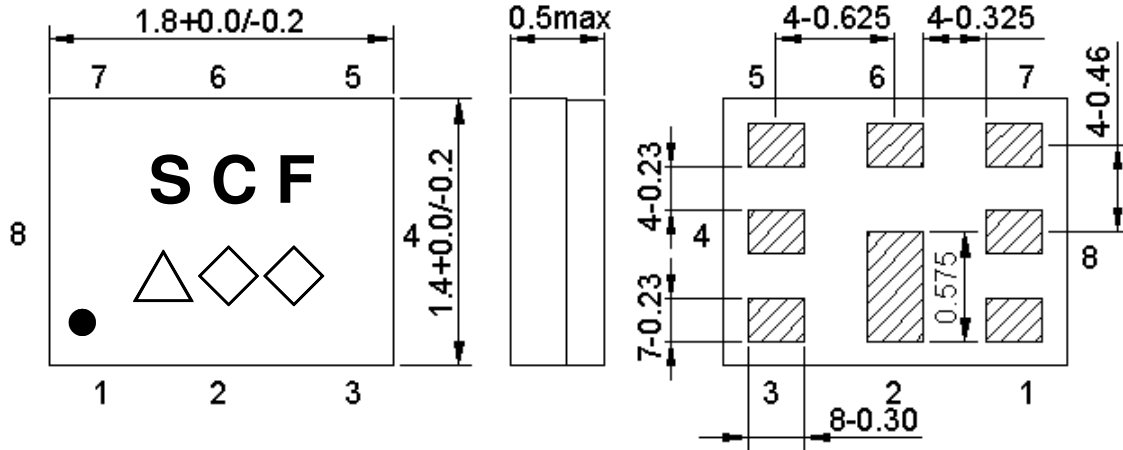

Marking name : SCF

Δ : Date code(2016 May → s ,....., 2019 Dec→m.)

◇◇: Lot Code.

Product Date Code. Follow below table.

Year	Jan	Feb	Mar	Apr	May	Jun	Jul	Aug	Sep	Oct	Nov	Dec
2016	n	p	q	r	s	t	u	v	w	x	y	z
2017	A	B	C	D	E	F	G	H	J	K	L	M
2018	N	P	Q	R	S	T	U	V	W	X	Y	Z
2019	a	b	c	d	e	f	g	h	j	k	l	m

Pin Configuration:

Pin No.	Pin Name	Description
1	Rx	Receive Pin
2	GND	Ground Pin
3	Tx	Transmitter Pin
4	GND	Ground Pin
5	GND	Ground Pin
6	ANT	Antenna Pin
7	GND	Ground Pin
8	GND	Ground Pin

F. FOOTPRINT:

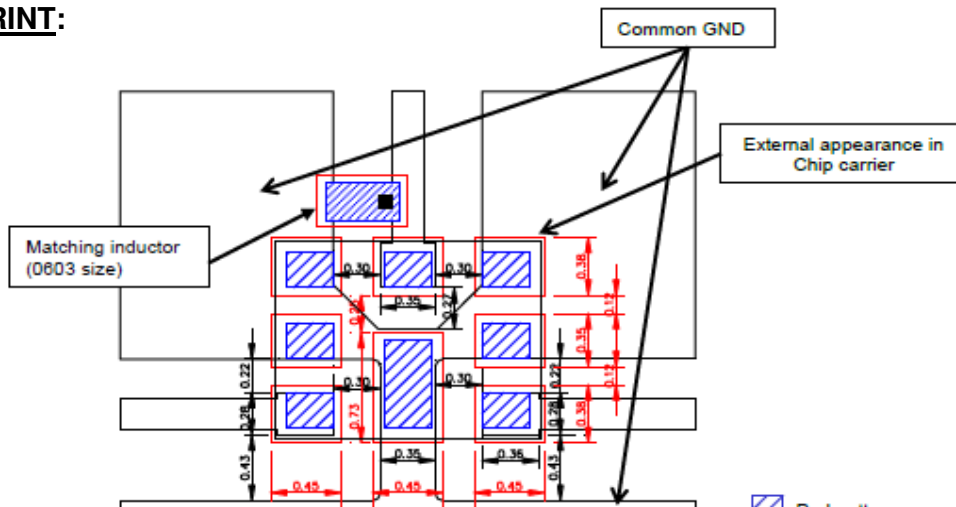

G. PACKING:

1. REEL DIMENSION

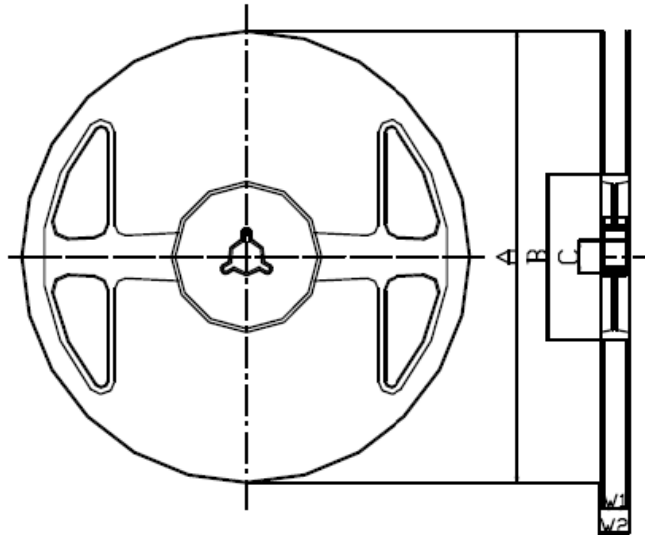

Materials of Reel

Material : Polystyrene + Carbon

Characteristics : Conforms to EIAJ-ET-7200A

Color : Black

Surface resistance (reference value) : $10^9 \Omega/\text{sq}$ Max.

Unit : mm

Code	Quantity	A	B	C	W1	W2
Z	3,000 pcs	$\phi 180.0 +0.0/-1.5$	$\phi 66.0 +/-0.5$	$\phi 13.0 +/-0.2$	$9.0 +1.0/-0.0$	$11.4 +/-1.0$

2. TAPE DIMENSION

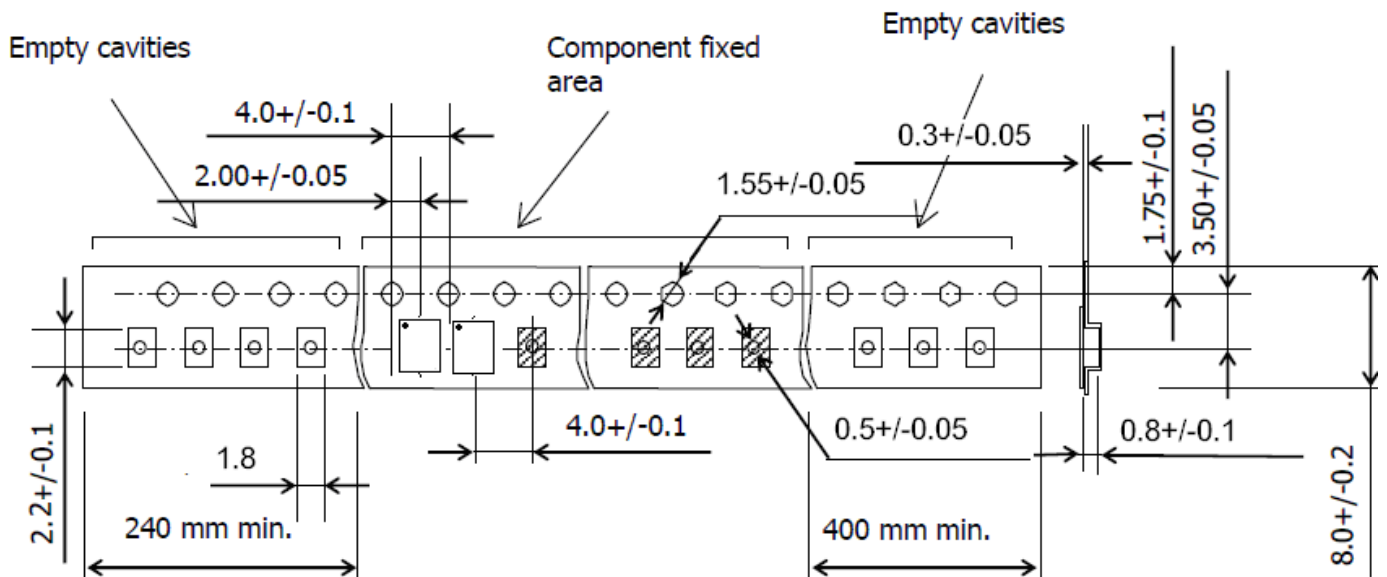

Unit : mm

H. RECOMMENDED REFLOW PROFILE :

1. Preheating shall be fixed at 150~180°C for 60~90 seconds.
2. Ascending time to preheating temperature 150°C shall be 30 seconds min.
3. Heating shall be fixed at 220°C for 50~80 seconds and at 245~260°C peak (min. 10sec).
4. Time : 2 times.

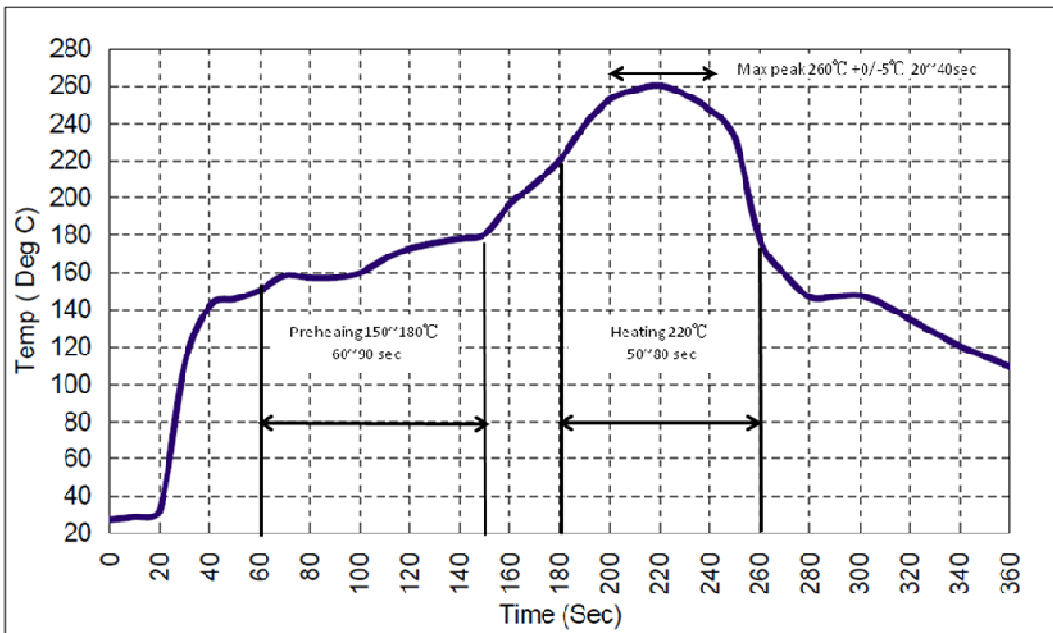

TAI-SAW TECHNOLOGY CO., LTD.

TST DCC
Release document