



# TAI-SAW TECHNOLOGY CO., LTD.

No. 3, Industrial 2nd Rd., Ping-Chen Industrial District,  
Taoyuan, 324, Taiwan, R.O.C.

TEL: 886-3-4690038 FAX: 886-3-4697532

E-mail: [tstsales@mail.taisaw.com](mailto:tstsales@mail.taisaw.com) Web: [www.taisaw.com](http://www.taisaw.com)

## Approval Sheet For Product Specification

Issued Date: 1/9/2007 (REV. NO: 1)

Product Name: SMD 5.0x3.2 38.4MHz Crystal Oscillator

TST Parts No.: TW0242A

Customer Parts No. : \_\_\_\_\_

Company: _____
Division: _____
Approved by: _____
Date: _____

Checked by: \_\_\_\_\_ Ryan Huang

Approval by: \_\_\_\_\_ Robert Chang

Date: \_\_\_\_\_ 1/9/2007



# TAI-SAW TECHNOLOGY CO., LTD.

No. 3, Industrial 2nd Rd., Ping-Chen Industrial District,  
Taoyuan, 324, Taiwan, R.O.C.

TEL: 886-3-4690038 FAX: 886-3-4697532

E-mail: [tstsales@mail.taisaw.com](mailto:tstsales@mail.taisaw.com) Web: [www.taisaw.com](http://www.taisaw.com)

## SMD 5.0x3.2 38.4MHz Crystal Oscillator

MODEL NO.: TW0242A

REV. NO: 1

### Features:

- Surface Mount Seam Weld Package
- Excellent Reliability Performance
- Good Frequency Perturbation and Stability over temperature

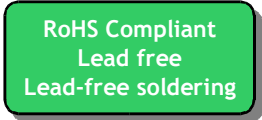

### Application:

- 3.3 V Supply Voltage Operation / Complementary CMOS Output
- Option-able stand-by function for output (Tri-state output).

### Electrical Characteristics:

TW0242A	Specifications
Nominal Frequency, Fo	38.400000 MHz
Storage Temperature Range	-40°C to +85°C
Operating Temperature Range	-20°C to +70°C
Power Supply Voltage, Vcc	3.3 V +/- 5%
Load	10KΩ // 15pF
“0” Level “1” Level	0.33 V max 2.97 V min
Power Supply Current, Icc	20 mA max
Frequency Accuracy <sup>1</sup>	+/-25 ppm max
Duty Cycle	40% ~ 60%
Rise Time ( 10% -> 90% of final RF level in Vp-p ) Fall Time ( 90% -> 10% of final RF level in Vp-p )	10 nsec max. 10 nsec max
Enable/Disable Function	PIN 1: High or Open, PIN 3:Enable PIN 1: Low, PIN 3:Disable

#Note 1: Frequency accuracy includes 25C tolerance, operating temperature range -20 to 70 deg C, aging and voltage or load change

# Mechanical Dimensions: (Unit: mm)

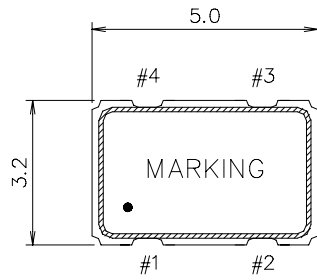

UNIT: mm

PIN#	FUNCTION
1	NO CONNECT/3-STATE
2	CIRCUIT AND COVER GROUND
3	OUTPUT
4	VDD

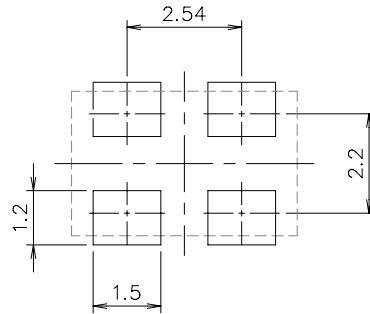
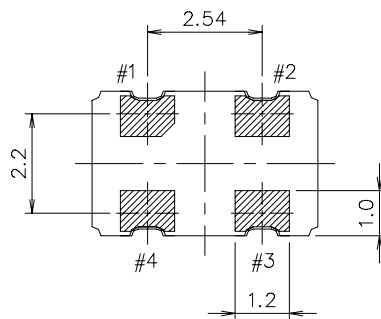
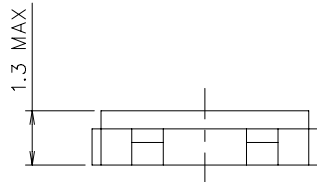

Recommended Soldering Pattern

## Test Circuit:

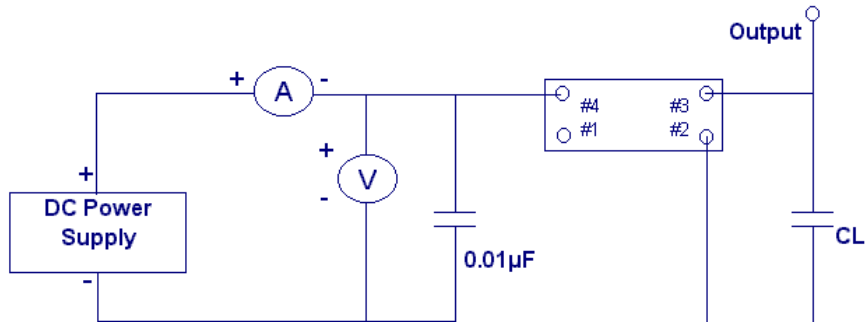

## Marking:

Line 1: 38.400(Frequency)

Line 2:  $\text{\textcircled{T}}$ WDA (TST logo + Product Code + Data Code + TST Internal Code)

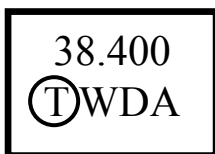

## Product Code Table

Year	2001 2005	2002 2006	2003 2007	2004 2008
Product Code	W	w	<u>W</u>	<u>w</u>

## Date Code Table

WK01	WK02	WK03	WK04	WK05	WK06	WK07	WK08	WK09	WK10	WK11	WK12	WK13
A	B	C	D	E	F	G	H	I	J	K	L	M
WK14	WK15	WK16	WK17	WK18	WK19	WK20	WK21	WK22	WK23	WK24	WK25	WK26
N	O	P	Q	R	S	T	U	V	W	X	Y	Z
WK27	WK28	WK29	WK30	WK31	WK32	WK33	WK34	WK35	WK36	WK37	WK38	WK39
a	b	c	d	e	f	g	h	i	j	k	l	m
WK40	WK41	WK42	WK43	WK44	WK45	WK46	WK47	WK48	WK49	WK50	WK51	WK52
n	o	p	q	r	s	t	u	v	w	x	y	z

## Packing:

### 1. Reel Dimension (Unit: mm)

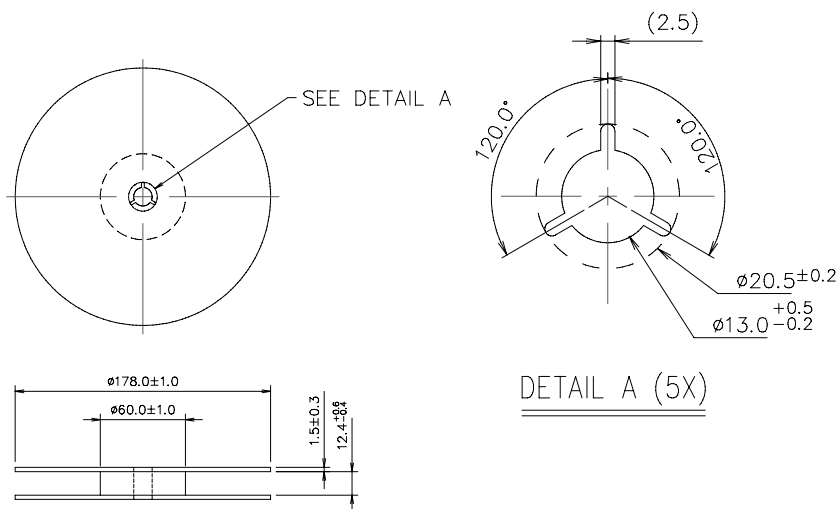

### 2. Tape Dimension (Unit: mm)

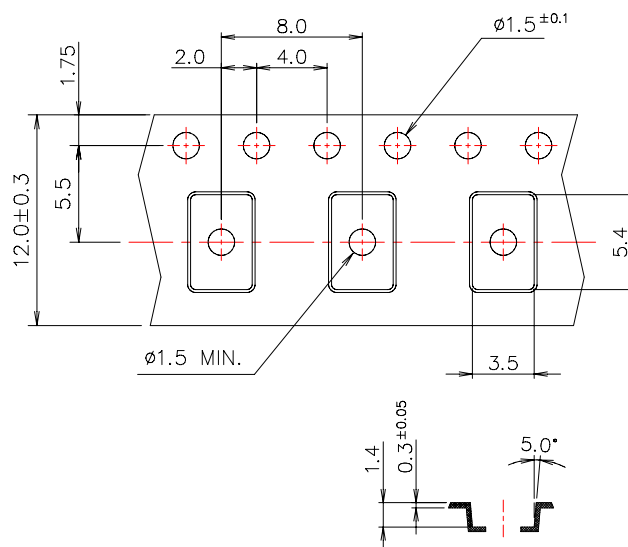

### [NOTE]:

1. Unless otherwise specified tolerance on dimension  $\pm 0.1$  mm.
2. Material: conductive polystyrene with color black
3. 10 pitch cumulative tolerance  $\pm 0.2$  mm.
4. Packing Direction: dot or the logo of marking should be close to the hole of tape.

### 3. PACKING DIRECTION:

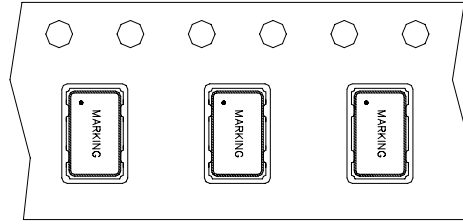

### Reflow Profile:

