



TAI-SAW TECHNOLOGY CO., LTD.

No. 3, Industrial 2nd Rd., Ping-Chen Industrial District,
Taoyuan, 324, Taiwan, R.O.C.

TEL: 886-3-4690038 FAX: 886-3-4697532

E-mail: tstsales@mail.taisaw.com Web: www.taisaw.com

Approval Sheet For Product Specification

Issued Date: 3/12/2007 (REV. NO: 1)

Product Name: SMD 3.2x2.5 29.491MHz Crystal Oscillator

TST Parts No.: TW0263A

Customer Parts No. : _____

Company: _____
Division: _____
Approved by: _____
Date: _____

Checked by: _____ Ryan Huang

Approval by: _____ Robert Chang

Date: _____ 3/12/2007



TAI-SAW TECHNOLOGY CO., LTD.

No. 3, Industrial 2nd Rd., Ping-Chen Industrial District,
Taoyuan, 324, Taiwan, R.O.C.

TEL: 886-3-4690038 FAX: 886-3-4697532

E-mail: tstsales@mail.taisaw.com Web: www.taisaw.com

SMD 3.2x2.5 29.491MHz Crystal Oscillator

MODEL NO.: TW0263A

REV. NO: 1

Features:

- Surface Mount Seam Weld Package
- Excellent Reliability Performance
- Good Frequency Perturbation and Stability over temperature

RoHS Compliant
Lead free
Lead-free soldering

Application:

- 3.3 V Supply Voltage Operation / Complementary CMOS Output
- Option-able stand-by function for output (Tri-state output).

Electrical Characteristics:

TW0263A	Specifications
Nominal Frequency, Fo	29.491000 MHz
Storage Temperature Range	-40°C to +85°C
Operating Temperature Range	-20°C to +75°C
Power Supply Voltage, Vcc	3.3 V +/- 5%
Load	10KΩ // 15pF
“0” Level “1” Level	0.33 V max 2.97 V min
Power Supply Current, Icc	10 mA max
Frequency Accuracy ¹	+/- 20 ppm
Duty Cycle	40% ~ 60%
Rise Time (10% -> 90% of final RF level in Vp-p) Fall Time (90% -> 10% of final RF level in Vp-p)	5 nsec max. 5 nsec max.
Enable/Disable Function	PIN 1: High or Open, PIN 3:Enable PIN 1: Low, PIN 3:Disable

#Note 1: Frequency accuracy includes 25C tolerance, operating temperature range -20 to 75 deg C, aging and voltage or load change

Mechanical Dimensions: (Unit: mm)

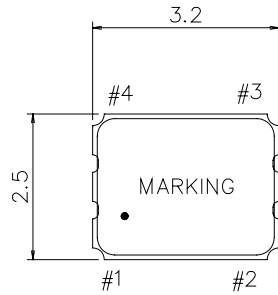

Unit :mm
 Pin Function
 1 : NO CONNECT/3-STATE
 2 : CIRCUIT AND COVER GROUND
 3 : OUTPUT
 4 : VDD

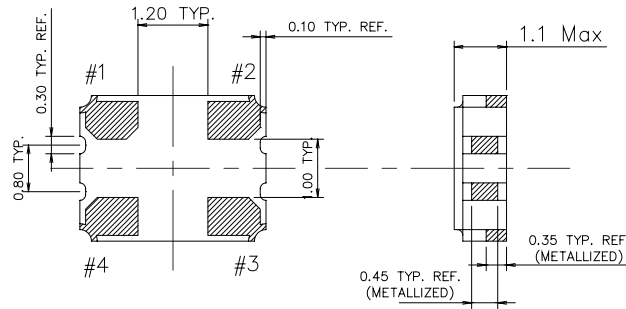

Test Circuit:

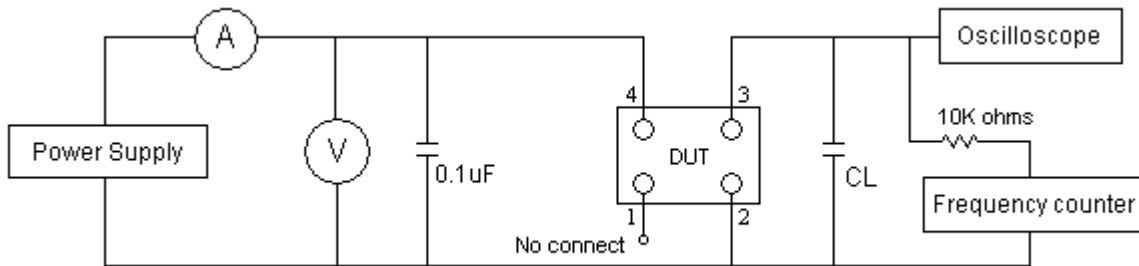

Output Waveform :

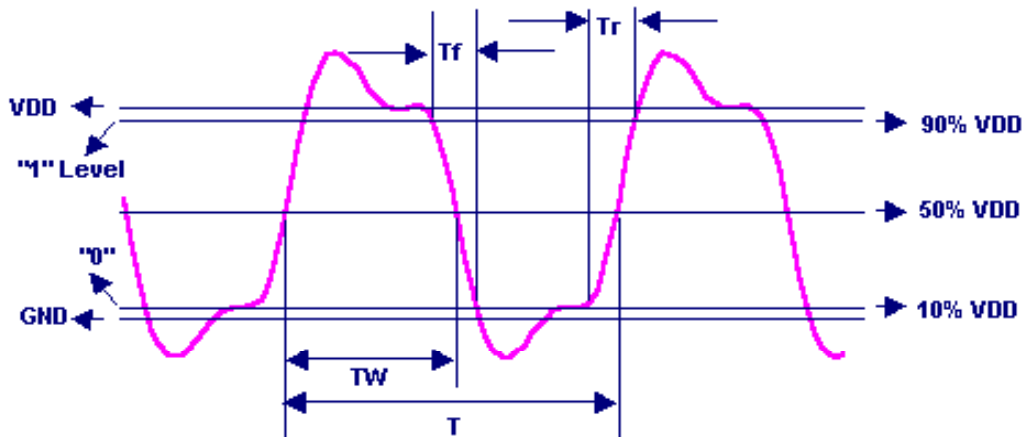

Input & Output condition :

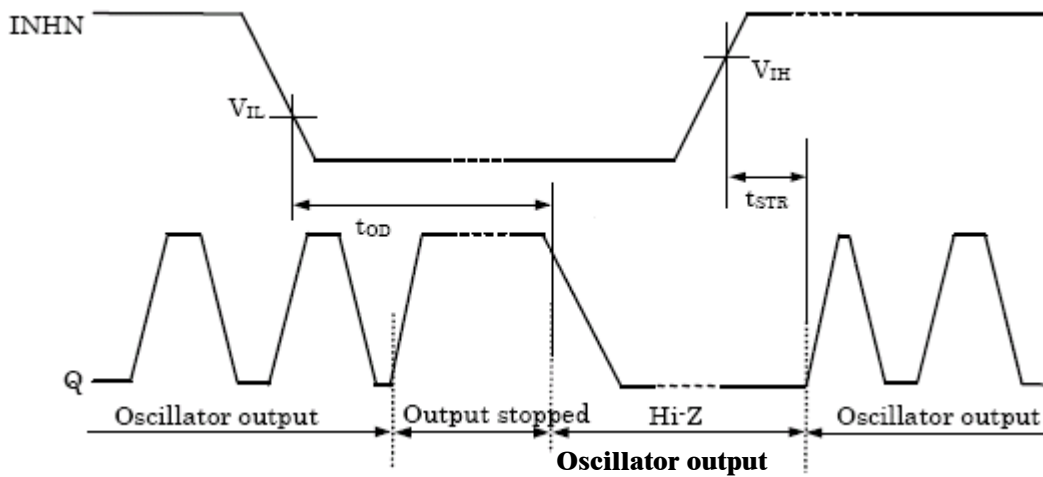

Parameter	Min.	TYP.	MAX.	Unit
High-level input voltage (V_{IH})	0.7VDD	-	-	V
Low-level input voltage (V_{IL})	-	-	0.3VDD	V
Output enable start time (t_{STR})	-	5	-	ms
Output disable delay time (t_{OD})	-	50	-	us

- When Pin#1 goes LOW, the Q (Pin#3) output stop and is momentarily held high level, and then Q output becomes high impedance (Hi-Z).

Marking:

Line 1: 29.491(Frequency)

Line 2: ⓈWDA (TST logo + Product Code + Data Code + TST Internal Code)

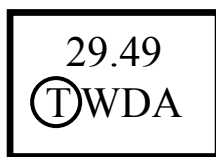

Product Code Table

Year	2001 2005	2002 2006	2003 2007	2004 2008
Product Code	W	w	<u>W</u>	<u>w</u>

Date Code Table

WK01	WK02	WK03	WK04	WK05	WK06	WK07	WK08	WK09	WK10	WK11	WK12	WK13
A	B	C	D	E	F	G	H	I	J	K	L	M
WK14	WK15	WK16	WK17	WK18	WK19	WK20	WK21	WK22	WK23	WK24	WK25	WK26
N	O	P	Q	R	S	T	U	V	W	X	Y	Z
WK27	WK28	WK29	WK30	WK31	WK32	WK33	WK34	WK35	WK36	WK37	WK38	WK39
a	b	c	d	e	f	g	h	i	j	k	l	m
WK40	WK41	WK42	WK43	WK44	WK45	WK46	WK47	WK48	WK49	WK50	WK51	WK52
n	o	p	q	r	s	t	u	v	w	x	y	z

Packing:

- **PACKING QUANTITY: 1K Pcs / Reel**
- **Reel Dimension (Unit: mm)**

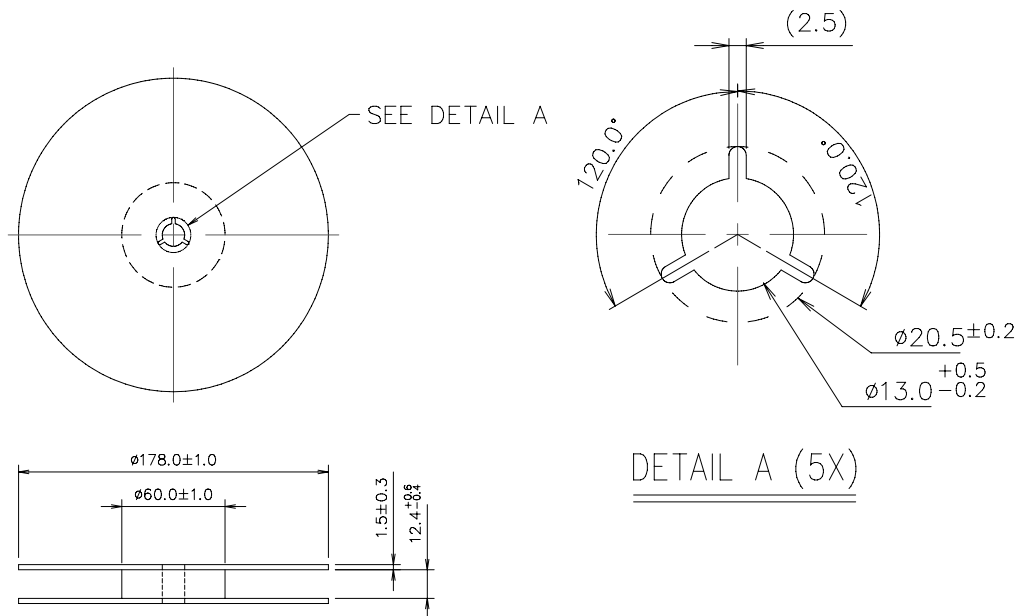

- **Tape Dimension (Unit: mm)**

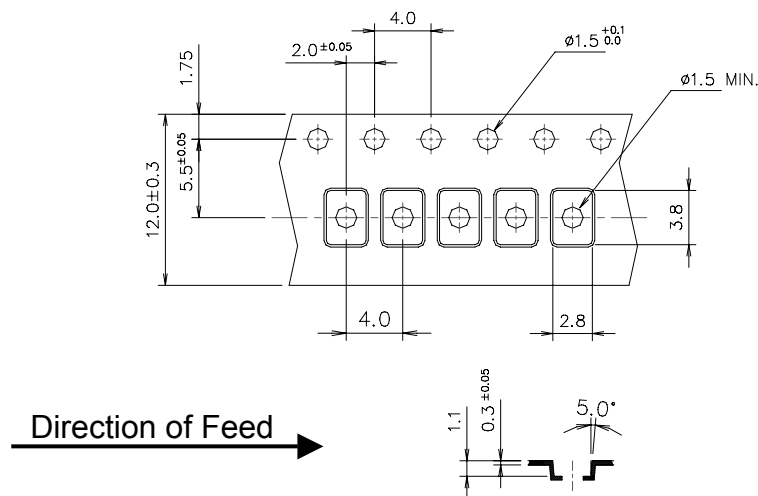

[NOTE]:

1. Unless otherwise specified tolerance on dimension ± 0.1 mm.
2. Material: conductive polystyrene with color black
3. 10 pitch cumulative tolerance ± 0.2 mm.
4. Packing Direction: dot or the logo of marking should be close to the hole of tape.

- **PACKING DIRECTION:**

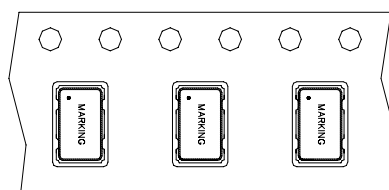

Reflow Profile:

